



# Raw water and sewage

The complete handbook  
for PE pipe systems

 **GPS**  
PE PIPE SYSTEMS

  
**aliaxis**

# Our vision and values



GPS PE Pipe Systems are a market leading range of high-performance fluid handling solutions, that provide the safe delivery of gas and clean drinking water to homes and businesses across the world.

MANUFACTURING  
IN THE UK

BESPOKE  
SERVICES  
FOR COMPLEX  
PROJECTS















CLOSE  
COLLABORATION  
WITH  
UK UTILITY  
COMPANIES



The GPS PE Pipe range forms part of the leading Aliaxis portfolio of sustainable pipework systems for water, gas and energy. We are experts in fluid management solutions, leading our industry in a way that anticipates the rapidly evolving needs of our customers, ensuring peace of mind for future generations.



# CONTENTS

<b>RAW WATER AND SEWAGE OVERVIEW</b>	<b>4 - 5</b>	
<b>HEALTH, SAFETY, QUALITY &amp; ENVIRONMENT</b>	<b>6 - 9</b>	
<b>POLYETHYLENE PIPE DESIGN AND INSTALLATION</b>	<b>10 - 13</b>	
Polyethylene pipe for Raw Sewage	14	
Pipe handling & storage	16	
Pipeline installation using no-dig techniques	18	
<b>CONNECTING PE TO PE – ELECTROFUSION</b>	<b>20 - 23</b>	
<b>CONNECTING PE TO PE – BUTT FUSION</b>	<b>24 - 27</b>	
<b>CONNECTING PE TO PE – FLANGE</b>	<b>28 - 29</b>	
<b>GPS PRODUCT RANGE OVERVIEW</b>	<b>30 - 89</b>	
Black Pipe	32	
Mechanical Fittings	44	
Frialen Fittings	50	
Spigot Fittings	66	
Case study - Ayshire Wastewater Network	75	
Pupped Fittings	76	
Accessories	88	
Case study - Gatehampton Borehole upgrade	89	



# Polyethylene Pipe Solutions for **Raw Water and Sewage Applications**



GPS PE Pipes has been manufacturing and supplying polyethylene (PE) pipe solutions for Raw Water and Sewage applications for a number of years, ensuring it has the knowledge and experience, backed up by exceptional product quality, to provide reliable, efficient solutions for gravity and pressurised vacuum raw water and sewage pipelines.

The flexibility and lightweight nature of PE pipe, combined with its corrosion resistant and low maintenance properties, makes it the ideal solution for various systems such as pumping systems, sewer outfalls, and bulk water transfer and raw water mains to name a few.

GPS can cater for the diverse requirements with its capability to manufacture PE pipe in sizes up to 1200mm, in a range of different SDRs and lengths. With its technical team on hand to advise with designing bespoke pipeline solutions, if needed, GPS is well placed to provide robust, cost-effective PE pipe solutions for raw water and sewage applications.

## FEATURES

- Available in both PE80 and PE100
- Sizes ranging from 20mm to 1200mm
- Available in standard SDRs 11/17/21/26  
*(Other SDRs are available on request)*
- Standard coil diameters available in sizes up to 180mm
- Standard coil lengths of 50m and 100m  
*(Other lengths are available on request)*
- Standard stick lengths 6m and 12m  
*(Other lengths are available on request)*
- A full range of compatible fittings
- Fully compliant to EN12201

## APPLICATIONS

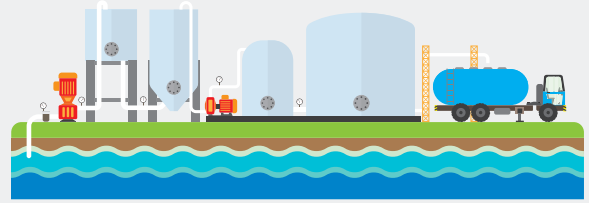

Offering reliable performance for an expected lifetime of 100 years, GPS provide fully-approved Polyethylene (PE) pipes and fittings which offers an overall system cost reduction based on lower maintenance and excellent hydraulic performance, as well as logistical and installation advantages.



## BENEFITS

- **Flexible** and light weight
- Resistance to corrosion
- **Low friction** and high flow rate
- **Cost savings** in transportation and installation
- Excellent lifetime cost savings
- Minimal maintenance
- **Reduction in carbon footprint**

## APPROVALS

Kitemarked to  
**BS EN 12201**  
**(KM508224)**

# Health, Safety, Quality & ENVIRONMENT



## HEALTH & SAFETY

At GPS PE Pipe Systems, we are committed to ensuring that health and safety is at the very top of our agenda in all of our activities. We look both within and beyond our immediate environment to ensure that we contribute to the highest possible standards of health and safety for all our stakeholders.

### Our Commitment

- Active support and participation in the creation of a positive health and safety culture at all levels within the Company, particularly at Senior Management level
- Maintain safe and healthy working places and systems of work and to protect all employees and others, including the public in so far as they come into contact with foreseeable work hazards
- Provide and maintain a safe and healthy working environment for all employees with adequate facilities and arrangements for their welfare
- Provide all employees with the information, instruction, training and supervision that they require to work safely and efficiently, and methods to assure employees understand and retain the knowledge
- Develop safety awareness amongst all employees and, as a result of this, create individual responsibility for health and safety at all levels
- Provide a safe environment for all visitors to the Company's premises, bearing in mind that these visitors may not necessarily be attuned to certain aspects of the Company's environment
- Control effectively the activity of all outside contractors when on the Company's premises. It is the intention of the Company that, apart from routine supervision and control of contractors, this aim will be achieved in part by demanding copies of the contractors' Safety Policies at the Tender stage, where appropriate
- Encourage full and effective two-way involvement and consultation on health and safety matters at all levels in the Company by utilising the management structure of the Company and the committees/forums already existing
- Ensure that this Policy is used as a practical working document and that its contents are publicised fully
- Review the details of this Policy on an annual basis and/or in line with regulatory and legislative changes
- Establish and publish specific, additional annual health and safety objectives which are realistic and measurable
- Develop an organisation which specifies the health and safety accountability of Directors, Managers, Supervisors and Employees

## USER GUIDELINES

GPS polyethylene products have been installed and used safely in large volumes over many years. However, good working practice is vital to ensure safety; our products should be handled and processed in accordance with the British Plastics Federation guidelines\*.

All PE80 and Excel® (PE100) pipe systems contain trace quantities of process residues and may also contain other materials such as pigments, antioxidants and UV stabilisers. Chemically unreactive, PE is regarded as being biologically inert, though some pipe materials contain low levels of additives which may be toxic.

GPS polyethylene products have been installed and used safely in large volumes over many years.

## INGESTION



**Ingestion of PE should be avoided.** Some pipe materials may contain additives which are harmful if swallowed. Materials specified for purposes other than carrying water may contain pigments which are not suitable for use with potable water. These materials may be hazardous if ingested in large quantities.

## INHALATION



**PE does not release harmful fumes at ambient temperature.** The threshold limit value for PE dust is 10mg/m<sup>3</sup> (8-hour time-weighted average in the working environment), but the generation of such levels when working with PE pipe and/or fittings is extremely unlikely.

## PHYSICAL CONTACT



**PE is not considered to be a skin irritant.** Where PE dust is generated by cutting or machining pipe or fittings, powder particles of PE dust may cause eye irritation by abrasion.

## FIRE CHARACTERISTICS



**When PE is heated in air, melting will occur at 120- 135°C and decomposition will commence at approximately 300°C.** Above this temperature PE will pyrolyse oxidatively to produce carbon dioxide, carbon monoxide, water and various hydrocarbons. These gases may ignite and provide heat which may accelerate the pyrolysis of more PE in the vicinity.

**In burning, molten droplets of material may be released which could ignite adjacent inflammable materials.** Actual cooling conditions in a real fire will be influenced by many factors such as location and oxygen availability, which will determine the progress and combustion products of the fire.

**Combustion of PE may release toxic materials.** Avoid inhalation of smoke or fumes. Also, do not allow PE dust to accumulate, since there may be a risk in exceptional circumstances of dust explosion, and consider carefully the siting of potential heat sources such as electrical equipment.

**In case of fire with PE Pipes, any fire extinguisher may be used.** Powder extinguishers are very effective in quenching flames. Water sprays are especially effective in rapid cooling and damping down a fire, but are not recommended in the early stages of a fire since they may help to spread the flames. Other factors will also influence the selection of fire extinguishers eg. proximity of live electrical equipment. Please refer to specific classifications of firefighting extinguishers.

## HANDLING OF MOLTEN MATERIAL



**During the fusion welding of PE pipe and fittings molten PE is formed. If allowed to have contact with skin it will adhere strongly and cause severe burns.** Such molten material has a high heat content and will remain hot for some time. Gloves should be worn where there is any risk of skin contact.

Small quantities of fumes may be given off by molten PE – these are more pronounced at higher temperatures and greater care must be taken where there is a risk of PE adhering to heated surfaces, such as heating plates used for welding. Ventilation must be provided to ensure safe working conditions.

\* [www.bpf.co.uk](http://www.bpf.co.uk)

# HEALTH, SAFETY, QUALITY & ENVIRONMENT

## QUALITY

GPS operates a quality assurance system in accordance with the requirements of BS EN ISO 9001. This is audited twice a year by BSI.



The quality assurance system imposes stringent standards of control throughout design, development and subsequent manufacturing and inspection processes.

Quality assurance  
BS EN ISO 9001



**PRODUCTS ARE SUBJECTED TO A RANGE OF DIMENSIONAL, MECHANICAL AND DESTRUCTIVE TESTS** carried out on a sample basis in accordance with the requirements of GPS Product Quality Plans



**UPON AGREEMENT, THESE QUALITY PLANS CAN BE AMENDED** to incorporate specific customer inspection and test requirements



**DETAILED RECORDS** are kept of dimensional and performance tests for each production batch



01224567 1890002

**EACH BATCH IS GIVEN A UNIQUE IDENTIFICATION NUMBER** that is reproduced on every fitting and pipe



This enables traceability to be maintained from raw material to finished products and for the provision of certificates of conformity, if required.



## DID YOU KNOW?



**WE CONSTANTLY MONITOR OUR BUSINESS ACTIVITIES WITH THE AIM OF MINIMISING THEIR IMPACT ON THE ENVIRONMENT.**



Quality assurance  
BS EN ISO 14001



## ENVIRONMENT

GPS operates an environmental management system in accordance with the requirements of BS EN ISO 14001. The system is audited twice a year by the BSI.

GPS continually monitors its business activities with the aim of minimising their impact on the environment. A number of on-going waste minimisation projects have been implemented in areas such as energy usage, product packaging and landfill waste.

A continual improvement culture is promoted within the company by setting environmental targets and objectives that are regularly monitored and reviewed.



# Polyethylene pipe design

# AND INSTALLATION

## PRESSURE RATINGS

Various ISO/CEN working groups have considered the design factors that should be used to determine the maximum operating pressures of polyethylene water and gas systems. ISO/DIS 12162 classifies types of polyethylene, by the minimum required strength (MRS).

This is the value of the lower prediction limit of the 50 year hoop stress in MPa obtained by extrapolation of data from stress rupture tests on completely water filled pipe samples under various internal pressures and temperatures. In the UK MDPE is classified as MRS 8 and HDPE is classified as MRS10, but these two types of polyethylene are referred to as PE80 and PE100. Maximum working pressures for polyethylene pipes are determined by the application of safety factors to these MRS values in accordance with UK Water Industry Standards. For water applications, GPS recommend derating the pressure rating of large diameter mitred bends to 0.8 x the pipe rating from which they are made. Bends incorporating 30° mitres should also be de-rated in sizes below 355mm. Thus 10 bar 30° mitres made into a mitred bend would be rated at 8 bar, and 16 bar 30° mitres would make a 12.8 bar fitting and so on. The fittings are fabricated from pipe complying with BS EN 12201-2 or BS EN 13244.

## PRESSURE TESTING

Pipe Pressure testing should be according to BS EN 805 or IGN 4-01-03, "Pressure testing of pressure pipes and fittings for use by public water suppliers".

## PIPE BENDING RADII FOR PE

A typical safe bending radius for SDR11 and SDR17 pipes is 25 times under optimum conditions (i.e. warm ambient temperature), increasing to 35 times the pipe OD in very cold weather. For thin-walled SDR26 and SDR33 pipes, these values should be increased by 50%. Electrofusion or mechanical joints and fittings should not normally be incorporated in sections of pipework which are to be bent. Instead a formed bend or elbow should be welded into the pipeline in order to prevent excessive stress. In the case of pipe supplied in coils, the above bend radius values apply only if pipe is bent in the same direction as it was previously coiled.

## BURYING PIPE

The dimensions of a trench line opening are normally governed by the pipe diameter, method of jointing and site conditions. Guidance should be sought on the selection and use of materials suitable for providing structural support to buried pipelines (IGN 4-08-01 (Bedding and Side fill Materials for Buried Pipelines) and WIS 4-08-02 (Specification for Bedding and Side fill Materials for Buried Pipelines). Normal minimum depth of cover for mains should be 900mm from ground level to the crown of the pipe. Trench width should not normally be less than the outside diameter of the pipe plus 250mm to allow for adequate compaction of side fill unless specialised narrow trenching techniques are used and/or specially free flowing and easily compacted side materials are employed.

MAXIMUM CONTINUOUS OPERATING PRESSURES AT 20° FOR STANDARD PE PIPES

Pipe Size/OD	SDR 11		SDR 17	SDR 21	SDR 26
*Pipes specifically sized for insertion lining applications	PE80	Excel (PE100)	Excel (PE100)	Excel (PE100)	Excel (PE100)
20mm	12.5	-	-	-	-
25mm	12.5	-	-	-	-
32mm	12.5	-	-	-	-
50mm	12.5	-	-	-	-
63mm	12.5	-	-	-	-
75mm	-	16.0	10.0	-	-
90mm	-	16.0	10.0	-	-
110mm	-	16.0	10.0	-	-
125mm	-	16.0	10.0	-	-
160mm	-	16.0	10.0	8.0	6.0
180mm	-	16.0	10.0	8.0	6.0
200mm	-	16.0	10.0	-	-
225mm	-	16.0	10.0	8.0	6.0
250mm	-	16.0	10.0	8.0	6.0
280mm	-	16.0	10.0	8.0	6.0
315mm	-	16.0	10.0	8.0	6.0
355mm	-	16.0	10.0	8.0	6.0
400mm	-	16.0	10.0	8.0	6.0
450mm	-	16.0	10.0	8.0	6.0
500mm	-	16.0	10.0	8.0	6.0
560mm	-	16.0	10.0	8.0	6.0
630mm	-	16.0	10.0	8.0	6.0
710mm	-	16.0	10.0	8.0	6.0
800mm	-	-	10.0	8.0	6.0
900mm	-	-	10.0	8.0	6.0
1000mm	-	-	10.0	8.0	6.0
1200mm	-	-	10.0	8.0	6.0

GPS can usually offer SDRs other than those shown in the table, e.g. for close for lining applications.

"In line with UK water industry recommendations, GPS de-rate large mitred bends by 0.8x the rating of the pipe from which it was made – please contact our Technical Support department for further information."

The values in the above table do not address any other safety-related issues associated with pipeline design.

**Finefill and pipe surround – Cohesive or granular materials which are free from sharp stones shall be used for the pipe surround.**

**Normal sidefill & backfill requirements**

For minor roads, excavated material can often be returned to the trench and compacted in layer thicknesses specified by the Utility Company. Relevant Water Industry specifications, e.g. WIS 4-08-02, permit much coarser material for the side and backfill for PE pipelines than is normally recommended for the bedding. However, heavy compaction equipment should not be used until the fill over the crown of the pipe is at least 300mm.

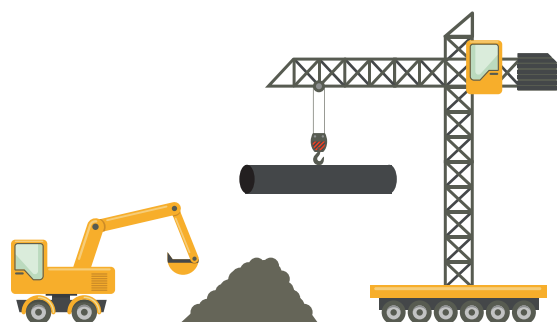

## STRUCTURAL DESIGN OF BURIED PE PIPES

There is often a requirement to provide proof of design security for buried pipelines.

The UK method was developed before PE was used extensively as a pipe material, and does not properly allow for the composite PE pipe/soil system. Values for long term safety factors against buckling and the total ('combined') stress equations are now recognised to be overly conservative. The latest version of the BS reflects this.

The European Plastic Pipes and Fittings Association (TEPPFA) and the Association of Plastics Manufacturers in Europe (APME) have sponsored extensive field trials from which an empirically based graph has been developed to aid PE pipe structural design (see below).



The graph gives the short term vertical pipe deflections that will occur for various burial conditions (materials used, plus degree of care taken) and pipe stiffness (SDRs), with long term deflection values determined by adding prescribed amounts.

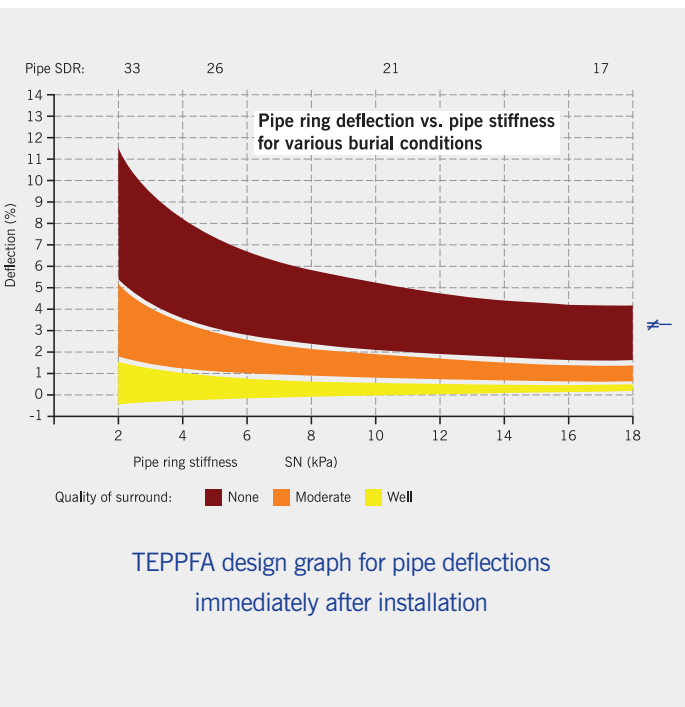

Long and short term pipe ring stiffness values are dependent upon the pipe's flexural modulus of elasticity, which is time, temperature and material dependent.

Assuming that the correct pressure rating of pipe is chosen for the specified duty, the total stress in the wall when the pipe is buried will always be less than the rated value (ref BS EN 1295-1:1997). The pipeline designer will simply need to decide how much deflection is acceptable in the particular circumstances (e.g. a higher value would be satisfactory in a field than under a road), and then select the PE pipe and type of surround accordingly. Note that long term deflections of up to 12.5% - 15% are completely safe for PE pipes.

Long and short term pipe ring stiffness values are dependent upon the pipe's flexural modulus of elasticity, which is time, temperature and material dependent.

There is currently no international consensus about the best values of modulus to use in every situation, but the following are generally considered appropriate at ambient temperature (20°C).

Type	Es (Short Term Modulus of Elasticity)	EI (Long Term Modulus of Elasticity)
PE80 (MDPE)	900 MPa	130 MPa
PE100 (HDPE)	1100 MPa	160 MPa

## ENTRY TO STRUCTURES

Polyethylene is unaffected by the constituents of concrete and the pipe can be partially or completely surrounded; however, protection should be afforded to the pipe surface to prevent the risk of fretting damage by wrapping the pipe in a heavy-duty polyethylene membrane prior to forming the concrete surround. The wrapping should extend beyond the concreted area. Should anchorage also be required, then a polyethylene 'puddle' flange may be incorporated. Achieving a water-tight seal where polyethylene pipes pass through concrete structures is difficult due to the materials natural flexibility; however provision may be made for external sealing.

The natural flexibility of a fully welded polyethylene pipeline can accommodate relatively large deflections. However, where a high degree of differential settlement is anticipated, consideration should be given to the use of support pads. The use of ‘hinged’ joints (rocker-pipes) is considered to be inappropriate for polyethylene pipeline installations.

### EMBANKMENT INSTALLATION

Where pipes are to be installed above existing ground level and then covered, they should not be laid until the mound of made up ground has been built up and compacted to one metre above where the crown of the pipe is to be. A trench should then be cut into the mound and the pipes laid in the conventional way.

## DID YOU KNOW?

PE Pipes provide a minimum life cycle of 100 years as per IGN 4-32-18

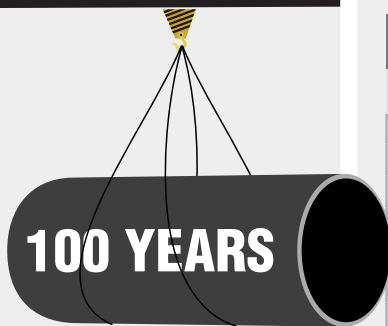

### ABOVE-GROUND SUPPORTED INSTALLATION

For exposed supported above ground pipework, proper anchorage is essential. The structure and anchorages must resist or accommodate thermal stresses or movement over the ambient temperature range to which the pipe system will be subjected.

It is preferable that a polyethylene pipe is installed at or near the maximum operating temperature such that pipes are thermally expanded whereby at that point clamps or supports can be bolted into position thus restraining the pipe from further movement. As the pipeline cools, tensile stresses are developed and the pipeline will remain straight between supports. If the pipeline then warms to its original installation temperature, it returns to its installation condition and sag between pipe supports is minimised. Supported polyethylene pipe systems may also be designed using the traditional methods, employing ‘flexible arms’ and ‘expansion loops’. For further information, please refer to BS EN 806 part 4 Annex B.

### SUPPORT

Recommendations for maximum support spacing are given in the table below. They are based on a mid-span deflection of 6.5mm when the pipe is full of water and assume a long term flexural modulus of 200MPa at an ambient temperature of 20°C. Pipe clips used for anchorage and support should have flat, non-abrasive contact faces, or be lined with rubber sheeting, and should not be over-tightened. The width of support brackets and hangers should normally be either 100mm or half the nominal pipe bore diameter, whichever is the greater.

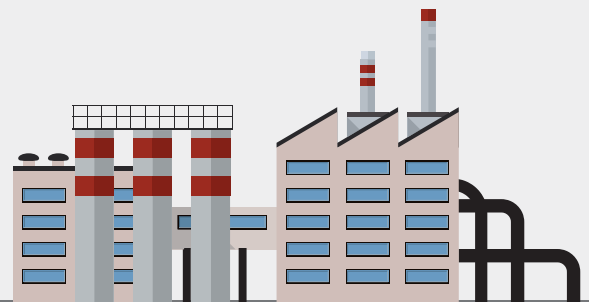

Above ground pipework maximum support spacing (metres)

Pipe	SDR 11	SDR 17	SDR 21	SDR26
20mm	0.6	N/A	N/A	N/A
25mm	0.7	N/A	N/A	N/A
32mm	0.9	N/A	N/A	N/A
63mm	1.1	N/A	N/A	N/A
90mm	1.3	1.2	N/A	N/A
110mm	1.5	1.3	N/A	N/A
125mm	1.6	1.4	N/A	N/A
160mm	1.8	1.6	1.6	1.5
180mm	1.9	1.7	1.7	1.6
200mm	2.0	1.8	1.8	1.7
225mm	2.1	1.9	1.9	1.8
250mm	2.2	2.0	2.0	1.9
280mm	2.3	2.1	2.1	2.0
315mm	2.5	2.3	2.2	2.1
355mm	2.6	2.4	2.3	2.2
400mm	2.8	2.5	2.4	2.3
450mm	2.9	2.7	2.6	2.5
500mm	3.1	2.8	2.7	2.6
560mm	3.3	3.0	2.9	2.8
630mm	3.5	3.2	3.1	2.9
710mm	N/A	3.4	3.3	3.1
800mm	N/A	3.6	3.5	3.3
900mm	N/A	3.8	3.7	3.5
1000mm	N/A	4.0	3.9	3.7
1200mm	N/A	4.4	4.2	4.0

*Note:* Figures given are for horizontal support spacings; and may be doubled for vertical support spacings.

# POLYETHYLENE PIPE FOR RAW SEWAGE

## DID YOU KNOW?

PE pipes do not corrode or fur up – ensuring velocity remains the same through the life of the pipeline.

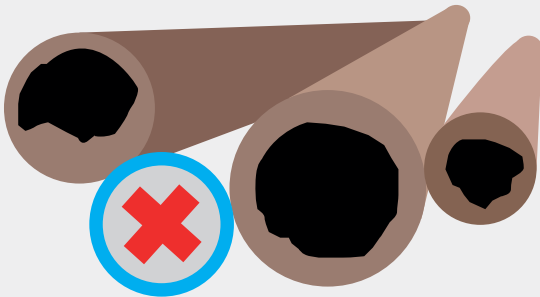

### BENEFITS

**LOW FRICTION**  
AND **HIGH FLOW RATE**

**EXCELLENT LIFETIME**  
**COST SAVINGS**



**LONGER LENGTHS**  
REDUCE RISK OF LEAKS



**COST SAVINGS**

DURING INSTALLATION

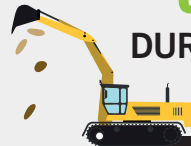

**CORROSION** AND  
**TUBERCULATION FREE**

CONSISTENT FLOW RATE  
DURING LIFETIME



**FLEXIBLE**

MATERIAL PROPERTIES

**SUPERIOR CRACK**  
**RESISTANT** PROPERTIES  
IN LARGER DIAMETERS





## PE80 BLACK PIPE

- Compliant to EN12201
- Available from 20 to 63mm
- Available in SDR11
- Maximum operating pressure of 12.5 bar as per EN12201

**SDR 11**



**12.5bar**



Compliant with  
**EN12201**

## EXCEL BLACK PIPE

- Compliant to EN12201
- Available from 75 to 1200mm
- Available in SDR11 / 17 / 21 / 26
- Maximum operating pressure of 16 bar as per EN12201

*Note:* Other SDRs and lengths can be made to order upon request. Please contact our Customer Services for further information.

**SDR**

11/17/21/26



**16bar**



Compliant with  
**EN12201**

# PIPE HANDLING & STORAGE

Although relatively lightweight, polyethylene pipe products should be treated with a similar level of caution as for heavier metallic pipe products.

Whilst polyethylene is a robust and resilient material, care should be taken not to cause excessive scuffing or gouging of the surface. Surface damage may occur during handling, storage and installation, but providing the depth of any score is no greater than 10% of the wall thickness, then the service performance of the pipe or fitting will not be affected.

## USEFUL SOURCES OF INFORMATION

The Health & Safety Executive (HSE) provides information and guidance on its website ([hse.gov.uk](http://hse.gov.uk)) which is relevant to the handling and storage of pipes and fittings, including but not limited to:

GS6	LOLER	PUWER	HSG150
Avoiding danger from overhead power lines	Lifting Operations and Lifting Equipment Regulations	Provision and Use of Work Equipment Regulations	Health and safety in construction



### DELIVERIES



The key stakeholders within the UK plastic pipe industry have created a best practice document entitled “Recommended Guidelines for the Safe Delivery and Unloading of Polyethylene Pipes” which provides a risk-based framework to assist with the safe handling of plastic pipe products.

This document has been commended by the HSE, please [click here](#) to download the document.



## SIX PIPE HANDLING STEPS

- 1 Pipes should be stored on flat, firm ground, able to withstand the weight of the materials and lifting apparatus
- 2 When pipes are loaded and unloaded, allow for some bending deflection – lifting points should be evenly spaced
- 3 Where slings are used, they should be wide, and made of a suitable non-metallic material (e.g. nylon or polypropylene), and not metal slings, hooks or chains

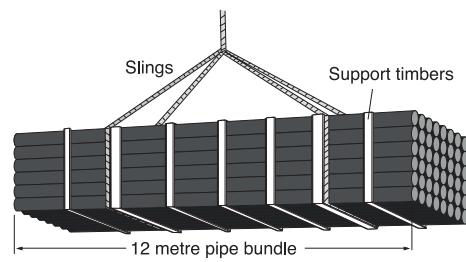

- 4 Standard six-metre bundles may be handled by a forklift, but longer lengths should be moved by a side-loader with a minimum of four supporting forks or by a crane with a spreader beam

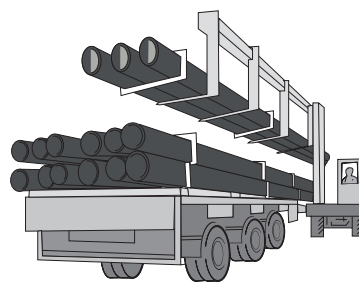

Handling of long lengths

- 5 Exercise special care when handling pipes in wet or frosty conditions in case they have become slippery
- 6 Pipes should never be thrown or dropped from any height, including from delivery vehicles



## HOW TO STORE YOUR PIPES

- Where larger diameter coils are to be stored vertically, they must be secured in purpose built racking with protective matting positioned underneath
- Never drag or roll individual pipes or bundles
- Keep pipes well away from sharp objects
- Do not allow pipes to be exposed to sunlight or any heat source for prolonged periods
- The packaging (battens, shrink-wrap, pallets, strapping etc.) is designed to provide protection to the pipes and should be kept intact until they are ready for use
- Do not allow pipes to come into contact with lubricating or hydraulic oils, gasoline, solvents or other aggressive materials
- Pipe lengths stored individually should be stacked in a pyramid no more than one metre high, with the bottom layer laid on timber battens and fully restrained by wedges

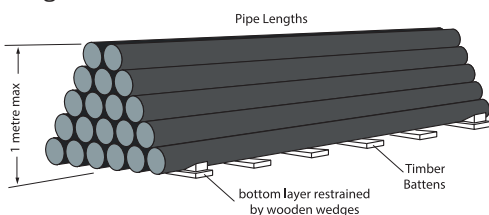
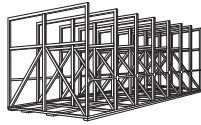

Storage of loose pipes

- Pipe bundles should be stored on level ground with the battens supported by timbers or concrete blocks, and stacked no more than three metres or three bundles high

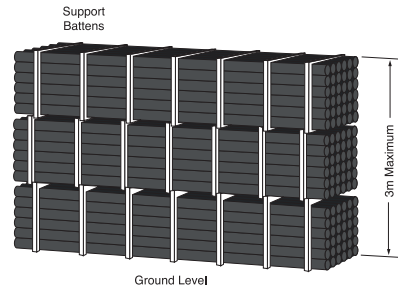

Storage of bundles

- Coiled pipe should be stored flat, on firm level ground with wooden battens beneath the bottom coil, and should be stacked no more than two metres high



Storage of coils

- Batches of coils delivered on pallets should remain secured to the pallet and only be broken down at time of use.

## COIL DISPENSING

**SAFETY FIRST:** Pipe held in coils is under tension and is strapped accordingly. Coils may be hazardous if released in the incorrect manner.



**PLEASE READ THE FOLLOWING GUIDELINES BEFORE ATTEMPTING TO RELEASE COILS**

PIPES 63MM AND ABOVE

**Pipes 63mm and above – with outer bands and additional strapping of individual layers**

- Coils of pipe above 32mm should only be dispensed from the appropriate coil trailer
- Do not remove any bands until the pipe is required for use
- Carefully remove the outermost layer first, only releasing the length of pipe immediately required
- Successive layers can then be released by removing banding one layer at a time as the pipe is drawn from the coil

PIPES 32MM AND BELOW

**Pipes 32mm and below – in coils which are shrink-wrapped**

- Do not remove the outer wrapping until the coil is almost fully unwound
- Take the free end of the pipe from the inside of the coil
- Take only sufficient pipe for immediate use from the coil

# PIPELINE INSTALLATIONS USING NO-DIG TECHNIQUES

## AVAILABLE PROCEDURES FOR PIPELINE INSTALLATIONS USING NO-DIG TECHNIQUES

Polyethylene pipe systems from GPS are designed to make the installation quicker, easier and more cost effective. Installation is as much a part of the cost equation as ease of maintenance and the cost of the pipe systems itself.

Polyethylene great advantage in installation is not only its lightness and flexibility but also its toughness allowing a number of low impact installation processes to be considered. These processes involve the minimum disruption and impact to the environment and often involve techniques such as “low-dig” and “no-dig”. Since the need for in-trench jointing is eliminated, the width of excavations can be minimised, resulting in reduced labour cost, less imported backfill and lower reinstatement costs.

Some of these techniques are described below.

### CHAIN TRENCHING

Modified mechanical diggers with oblique profiled buckets are ideal provided that the spoil produced by the digging action is relatively fine.

Chain excavators in particular will break up the original ground finely and permit trench widths only 50 to 100mm greater than the PE pipe outside diameter.

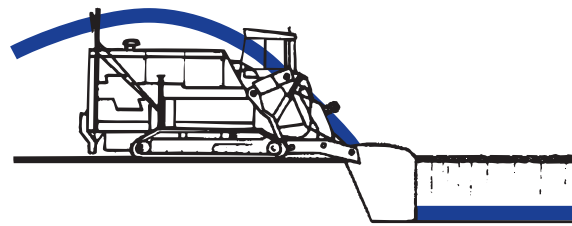

### MOLEPLOUGHING

This technique was originally developed for laying land drainage and adapted for installation of gas and water pipes in rural areas. It enables pipelines to be laid across rural landscapes with minimum disruption to agriculture, while the ground can also be reinstated virtually to prime condition. A new PE pipe string is literally ploughed into the ground to a prescribed depth and ground restore immediately to its original condition.

## NO-DIG



Impact Moling illustration (courtesy of TT-UK Ltd)

### IMPACT MOLING

Impact moling is highly economic in instances such as road crossing, where considerable savings can be made over traditional open-cut excavation methods. Traffic control systems are often unnecessary, for example, and the cost of excavation, backfill and reinstatement is virtually eliminated. With this installation method, excavation is only necessary at the starting and finishing locations of the pipeline – in order to accommodate the mole and its ancillary equipment. The impact mole drives a borehole between launch and reception pits, leaving the ground surface undisturbed.

## PIPE BURSTING

Size-for size replacement or upsizing of existing iron pipelines can be achieved with significant savings by the pipe bursting method. With this technique an existing main is cracked open and the borehole simultaneously expanded by a mole. Modern pipe bursting moles, especially those with hydraulically expanding segments, can crack and open out an unserviceable pipeline, even if it has repair collars or concrete surrounds. Risk of damage to adjacent utility installations is minimised by using hydraulic moles, helping to maximise the cost advantages of using the existing “hole in the ground”.



## SLIP-LINING / INSERTION

This is a rehabilitation and renovation technique in which a replacement PE pipe string of smaller size is inserted into an existing decommissioned pipeline.



Although rarely necessary, pressure grouting of the annular gap can enable the existing pipeline to be rehabilitated structurally, whilst also reinforcing the hoop strength of the new PE pipe.

Though some reduction in flow capacity is inevitable, this can be minimised by careful preparation and cleaning of the old pipe so that the largest possible diameter of new PE pipe can be inserted. In many instances an average annular clearance of as little as 5% of the main’s diameter-

less still for sizes above 300mm – has proven adequate where pipelines are reasonably straight and of uniform bore. In pressure pipelines, the reduction in carrying capacity can be compensated for by an increase in internal pressure. In gravity

applications any effect of bore reduction is minimised both by the exclusion of ground water entering the system and by the improved flow characteristics of PE.

# TECHNIQUES



## DIRECTIONAL DRILLING

This is a pipe installation technique that was originally developed for oil and gas wells, however it is now increasingly used for PE pipe. It allows pipelines to be installed under roads and rivers etc. with minimal excavation work. The technique involves drilling a hole under an obstacle and then pulling the pipeline back through an enlarged hole, from the far side.



## CLOSE FIT INSERTION SYSTEMS

Close-fit rehabilitation systems offer two advantages. They never require grouting and, in most cases, even though there is a slight reduction in pipe diameter, the exceptional hydraulic smoothness of PE pipe actually enables flow capacity to be increased.

If the old main is structurally unsound, close-fit PE linings can be SDR17 or SDR11, depending on ground cover and pressure requirements. For pipelines that are strong but leaking, PE lining thickness down to SDR33 or thinner should be considered. With a 100 year minimum life and exceptional gap-bridging performance, thin-walled PE linings provide a cost effective sealing membrane that is totally reliable.

# Connecting PE to PE

# ELECTROFUSION

## PRINCIPLES OF ELECTROFUSION

Electrofusion fittings incorporate an electrical heating coil to which an Electrofusion Control Unit (ECU) supplies the electrical energy necessary to heat the coil. When the coil is energised the material adjacent to it melts and forms an expanding pool which comes into contact with the surface of the pipe. The continued introduction of heat energy causes the pipe surface also to melt and a mixing of pipe melt and fitting melt takes place; this is vital to produce a good weld. Following the termination of the heat cycle, the fitting and pipe are left to cool and the melted material solidifies to form a sound joint.

Preparation and assembly procedures are similar for all electrofusion systems. Some fittings require the fusion time to be entered into the ECU manually and are therefore described as manual. Some fittings incorporate auto-recognition aids and the ECUs are therefore described as automatic. Some of our fittings are Barcode read only and can only be read by an ECU that has Barcode read facility. All of our standard fittings require a 39.5V supply. Please be aware that the Barcode read only fittings are variable voltage and are determined by the ECU box via the Barcode read facility.

Hot and cold zones sometimes called melt and freeze zones, are formed after energising the coil. The length of these zones is particularly important. Each zone ensures that fusion is controlled to a precise length of the socket of the fitting and

that the melt pressure is also controlled throughout the entire jointing process. The precisely controlled pitch and positioning of the coil in relation to the inner surface of the socket ensures uniform heat distribution.

## ELECTROFUSION CONTROL UNITS (ECUS)

Electrofusion Control Units are designed to operate from an electrical mains or field generator supply having an output of 110V and a rating of generally 3.5 to 7.5kVA for 39.5V. Frialen XL fittings require a specialist ECU box that is 3 phase (Please contact Technical Support for further information).

All ECUs manufactured after 1st January 1996 for sale into Europe should comply with the Electro-Magnetic Compatibility Directive and be CE marked, also should comply with GIS ECG1.

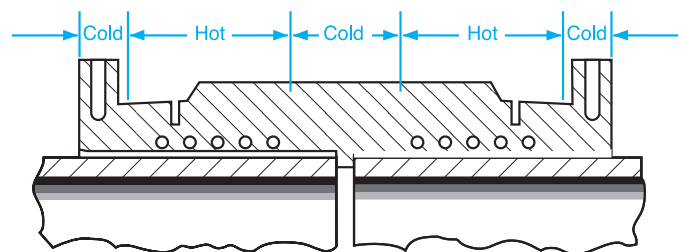

## DID YOU KNOW?

**A correctly installed electrofusion coupler will last as long as the pipe – in excess of 100 years**



### BARCODES AND ECUS

ECUs can be supplied with the ability to read a bar code when connected to an electrofusion fitting. The machines have a bar code reading device that the operator uses to scan the data contained within the bar code. Once the bar code data has been entered, the ECU will usually display a description of the fitting and its size, which should be checked by the operator before proceeding with the electrofusion process.

The bar code system will automatically adjust the fusion time by small amounts to compensate for variations in ambient temperatures. ECUs should contain data logging facilities to ensure traceability of welding parameters. An output socket allows this information to be downloaded onto a computer database or printer to obtain a complete record of the joints that have been made.



ECUs are now available, that can confirm the presence of clamping during the fusion cycle and provide photographic evidence and joint location data, based on satellite navigation systems technology. Additional control over joint quality can be achieved using ECUs that will lock out the unit in the event of any discrepancy in the jointing procedure. To reinstate the unit to full operation, it will be necessary to seek authorisation before the unit can be unblocked and jointing continued.

### TRACEABILITY BARCODES

Most electrofusion fittings are fitted with traceability barcodes that can be read by any ECU with a traceability option. This barcode contains specific information regarding the manufacture of the product such as: the name of the fitting manufacturer, the type of fitting, the size of the fitting, the production batch number, the manufacturing location, the product SDR rating, the product raw material, the material status, the material MRS and the material melt flow index.



Please note all of our Frialen Electrofusion Fittings have 4.0mm pins. Some ECU's may require adapter pins to operate.

## ELECTROFUSION SEQUENCE

The sectional drawings show the jointing sequence from energising the coil until completion of fusion. The whole cycle is electronically monitored by the electrofusion control unit (ECU).

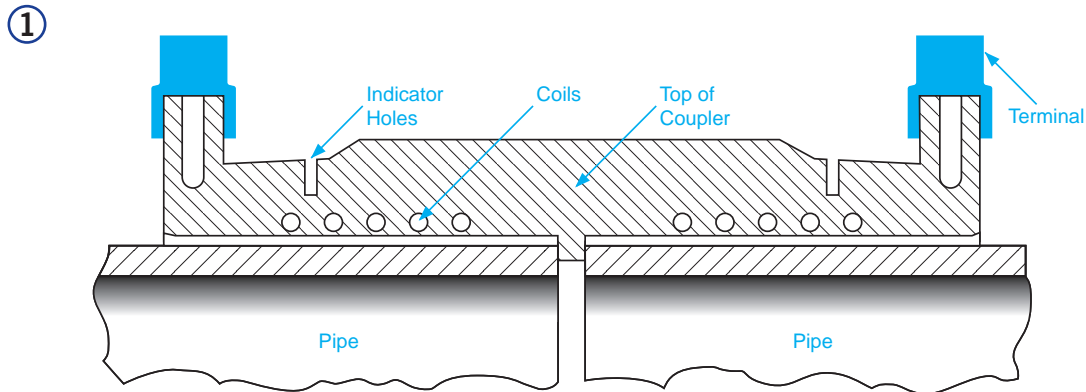

Pipe positioned in coupler prior to energising coil.

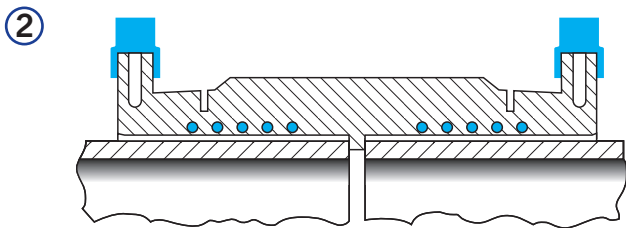

Coil energised.

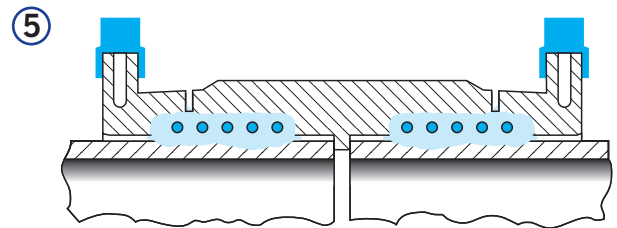

Heat transfers to pipe wall and pipe material starts to melt.

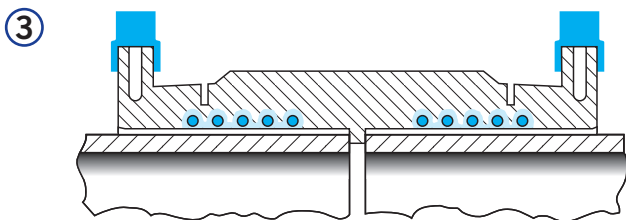

Material surrounding coils starts to melt.

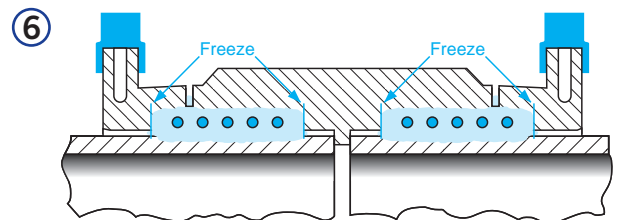

Melt solidifies at the start of the cold zones, thereby sealing the melt zone. Further input of energy causes increase in melt pressure.

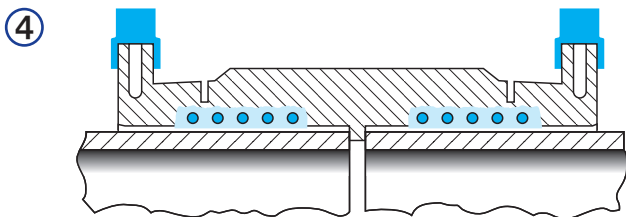

Area of melt extends leading to expansion towards pipe surface.

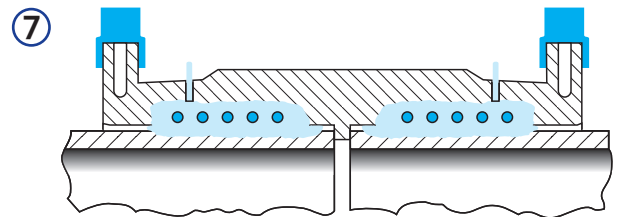

Melt pressure reaches optimum value at end of energising cycle. Emergence of the melt at the indicator holes shows that fusion is complete. *Please note: larger Dia. fittings have visual indicators that change colour to red when fused.*

## PRE-JOINTING CHECKS

- 1 Use equipment that is clean, in good condition and regularly maintained.
- 2 Mechanical pipe preparation tooling must be used wherever possible.
- 3 Ensure that the cutters/blades of mechanical scrapers are clean and in good condition.
- 4 Check that you have somewhere clean and dry to place tools and equipment during the electrofusion process, and enough access to the work area.

## DO'S

- **DO WORK SAFELY**
- Do understand the principals of electrofusion (refer to pipe manufacturers details if necessary).
- Do use a shelter and ground sheet, (a suitable anti-slip surface) in both dry and wet conditions to minimise contamination. Use end protection to pipes, (plugs or caps) to eliminate draughts.
- Do always use appropriate clamps for the true alignment, restraining and re-rounding of all pipes, both sticks and coils.
- Do ensure control box voltage is compatible with fitting.
- Do ensure pipe and fittings to be jointed are compatible with each other.
- Do cut pipe ends square for all electrofusion socket fittings.
- Do fully prepare pipe and/or spigot surfaces.
- Do keep prepared pipe and/or spigot surfaces and fittings clean.
- Do assemble joint and fuse immediately following preparing the pipe.
- Do check that the fusion time displayed by the ECU (automatic or manual) matches the fusion time on the fitting. In the case of automatic recognition, if the time is different to that shown on the fitting, do not weld.
- Do ensure correct fusion and cooling times are observed and adhered to.

- Do always input the correct operator code and job code to allow for full traceability with Electrofusion Control Units with data retrieval facilities.
- Do mark finished joints with a joint number/data.
- Do ensure that the fusion indicators have risen, if there is no apparent movement of one or both of the indicators, the joint should be cut out and a new joint made (WIS 4-32-08).
- Do ensure that when jointing tapping tees the fitting is correctly positioned on the pipe before fusion. Following the required quality inspections and pressure testing of the welded saddle fitting, the pipe can then be tapped through.
- Do always enter your I.D. details should the ECU request it. Enter your operator and job code to allow full traceability.
- Do always ensure you mark/sign the completed joint with the number issued from the ECU, along with the date if given. This is imperative for full traceability.

## DONT'S

- Do not start any electrofusion joint unless it can be completed without interruption.
- Under no circumstances shall an attempt be made to carry out a second fusion cycle on any fitting. This is a WIS 4-32-08 Specification and shall be adhered to.
- Do not use dirty or contaminated fittings.
- Do not use fittings from split or torn bags, all fittings should remain bagged until immediately prior to use.
- Do not ever touch prepared fusion/jointing surfaces.
- Do not allow prepared fusion/jointing surfaces to become wet or damp.
- Do not remove clamps from fitting until cooling time has elapsed.
- Do not remove integral cutter from the stack/saddle (contamination risk).

Connecting PE to PE

# BUTT FUSION

## GENERAL

Butt Fusion is a jointing method which allows on-site jointing of pipes 90mm and above. It is a thermofusion process which involves the simultaneous heating of the ends of two components which are to be joined, until a melt state is attained at each contact surface. The two surfaces are then brought together under controlled pressure for a specific fusion/cooling time and homogeneous fusion takes place.

The resultant joint is fully resistant to end thrust and has identical performance under pressure to the pipe.

This method of jointing requires an electrically heated plate to raise the temperature of the pipe ends to the required fusion temperature. It is used for both PE80 and PE100 grades of material for pipes of size 90mm and above of the same Standard Dimension Ratio (SDR).

Automatic Butt Fusion machines are to be preferred, however particularly when jointing the larger pipe sizes, semi-automatic machines with full data retrieval may be considered.

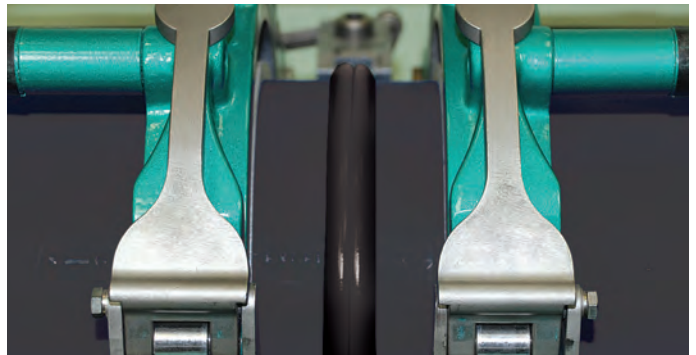

Excel Black in the final stage of Butt Fusion process

## DID YOU KNOW?

**Butt Fusion provides the greatest joint integrity of any jointing method**





## TRAINING COURSES

It is essential that installers of polyethylene pipe systems have received thorough training. Training leading to nationally recognised qualifications can be completed at a number of organisations.

## BUTT FUSION JOINTING PRINCIPLES

Butt Fusion machines can be capable of welding moulded fittings directly onto pipe but not in all circumstances as it can depend on the design and make of the equipment. GPS offers two ranges of fittings to provide the greatest flexibility.

### Spigot Fittings

These unpupped fittings are long enough to be gripped for Butt Fusion in some types of machines.

### Pupped Fittings

Pupped fittings are fabricated in our factory by butt-fusing lengths of pipe (pups) to each leg of a spigot fitting. The pup can be gripped by clamps of site Butt Fusion machines.

GPS standard pupped fittings have a 0.5m length pup for sizes up to 400mm and a 1.0m length pup for sizes of 450mm and above.

### Welding in Cold Weather

When Butt Fusion jointing at temperatures below -5°C, a space heater should be provided for the welding shelter to raise the local temperature above 0°C.

## EQUIPMENT

- Generator to supply the heater plate, trimmer and hydraulic pump
- Butt Fusion machine fitted with the correct size clamp shells, trimmer, heater plate, hydraulic pump and timer
- Pipe support rollers
- Welding tent
- External/internal de-beading tool
- Bead gauge
- Cleaning material, lint-free cotton cloth or paper towel
- Digital thermometer with surface probe to check heater plate
- Pipe end caps
- Baseboard
- Pipe cutters
- Air temperature thermometer
- Indelible marker pen
- Timer

## JOINTING METHOD PRE-JOINTING CHECKS

### Before commencing a welding operation:

- Ensure that equipment used is clean, in good condition and regularly maintained
- Ensure that the correct jointing parameters for the machine type and pipe are known
- Check that the heater plate is clean and dry
- Check that the trimmer is clean and that the blades are not damaged and in the correct position for required pipe size
- Ensure clamp liners and securing screws are of the correct size
- Ensure that the generator is in good condition and has sufficient fuel
- A tent is available to provide shelter during welding and end caps are available.
- The pipes and/or fittings to be jointed are of the same size, SDR and material.

## DUMMY WELDS

Even though washing of the heater plate may remove large deposits of dirt, very fine particles of dust may still remain on the heater plate. To remove such dust it is necessary to make a dummy joint at the start of each jointing session, whenever the plate has been allowed to cool below 180°C, or at a change of pipe size. Two dummy joints must be made if the pipe size is greater than 180mm.

A dummy joint can be made using pipe off-cuts of the same size, SDR and material as the pipe being installed however, it is not necessary to actually make a joint as the procedure can be discontinued after the full heat cycle has been completed. In the case of Automatic machines the abort button can be used to stop the process after the heat soak period has elapsed.



Butt Fusion machine prior to commencement of fusion process

## PRE-JOINTING CHECKS

- Use equipment that is clean, in good condition and regularly maintained.
- Ensure the correct jointing parameters for the machine type and pipe are known.
- Check that the heater plate is clean and dry.
- Check that the trimmer is clean and that the blades are not damaged and in the correct position for the required pipe size.
- Ensure clamp liners and securing screws are of the correct size.
- Ensure the generator is in good condition and has sufficient fuel.

## WELDING PROCEDURE

- 1 With the machine in the open position place the pipes in the clamps with the ends adjacent to the trimming tool and with the pipe markings aligned.
- 2 Align and level the components using external support rollers.
- 3 Tighten the pipe clamps to grip and re-round the pipes.
- 4 Cover the free ends of the pipes to prevent cooling of the plate by internal draughts.
- 5 Switch on the trimming tool and bring the clamps slowly together so that the pipe ends are moved against the trimming tool until continuous shavings are cut from each surface.
- 6 Keep the trimming tool turning whilst separating the clamps to avoid steps on the trimmed surfaces.
- 7 Remove the trimming tool taking care not to touch the trimmed pipe ends.
- 8 Remove loose shavings from the machine and pipe ends. Do not touch the prepared surfaces or place hands between the pipe ends.
- 9 Check that both surfaces are completely planed. If they are not then repeat the trimming process.
- 10 Bring the clamps together and check that there is no visible gap between the trimmed faces.
- 11 There should be no discernible mis-match on the outside diameter up to and including 180mm and less than 10% of the wall thickness for pipes greater than 180mm. If the mismatch is greater than these values then the pipe must be realigned and re-trimmed.
- 12 Automatic machines will measure the drag pressure and compensate for this but with the earlier manual machines, there was a need for this to be assessed accurately prior to making each fusion joint and added to the basic ram pressure values shown on the machine.
- 13 With the machine in the open position place the heater plate assembly on the machine, checking that it is up to the correct temperature.
- 14 The automatic Butt Fusion cycle can now be commenced whereupon the required interface pressure will be maintained until a uniform bead of the correct size is formed on each pipe.
- 15 After the initial bead up, the pressure in the hydraulic system will be reduced to between zero and the drag pressure, so as to control the bead growth during the heat soak time.
- 16 When the heat soak time is completed, the machine will automatically open and remove the heater plate before bringing the pipe ends together under the prescribed interface pressure.
- 17 The prescribed pressure must be maintained for the required minimum cooling time.
- 18 After this time the assembly can be removed from the machine but should not be handled excessively for the required period.

## POST WELDING CHECKS

- 1 Examine the joint for cleanliness and uniformity and check that the bead width is within the specified limits.
- 2 Remove the external bead and if required the internal bead using suitable debanding tools.
- 3 The beads and joint should be numbered/coded using an indelible marker pen to correspond with the joint details entered into the butt fusion machine data retrieval system.
- 4 The beads should be twisted at several positions and if a bead is seen to split at any point or deformities are present on the underside, then the joint should be cut out from the pipeline and remade. If a similar defect reoccurs, all further jointing should cease until the equipment has been thoroughly cleaned, examined and new trial joints made which are shown to be satisfactory.



## DO'S

- **DO WORK SAFELY (If in doubt – always ask)**
- Do understand the principals of butt fusion (refer to pipe manufacturers/machine suppliers guidelines if necessary).
- Do always input correct operator code and job code to allow for full traceability with Automatic Butt Fusion machines.
- Do mark finished joint with joint number.
- Do use a shelter and ground sheet (a suitable anti-slip surface\*), both in dry and wet conditions, to minimise contamination, and fit end protection to pipes, (plugs or caps) to eliminate draughts.
- Do ensure pipes are aligned correctly and supported on pipe rollers to minimise drag.

- Do position pipes in clamps with pipe markings aligned and to the top.
- Do perform dummy welds at the start of every welding session, when changing pipe size or if the heater plate has been allowed to cool (one dummy weld on pipe size 180mm and below and two on larger pipe sizes).
- Do ensure that when trimming, a continuous ribbon of material is produced from both pipe ends before commencing feathering operation.
- Do always use trimmer and heater plate stands provided.
- Do always remove swarf from underneath pipe ends and machine chassis following trimming.
- Do visually check that both pipe ends are completely trimmed.
- Do always check pipes for alignment and gaps around the entire circumference of the abutted pipes.
- Do always remove external bead from completed joint, inspect for slit defects/bead uniformity then bag and label with corresponding joint number for full traceability.

## DONT'S

- Do not attempt to use equipment unless trained to do so.
- Do not attempt to weld pipes of different wall thickness.
- Do not touch trimmer blades when cleaning and especially when in motion, blades are very sharp and can cause serious injury.
- Do not touch heater plate (unless to clean when cold).
- Do not leave swarf inside pipe or on machine chassis.
- Do not introduce dirt onto trimmed pipe ends at any time, particularly when removing swarf.
- Do not remove pipes from machine until cooling time has elapsed.
- Do not attempt to install pipe until fully cooled.
- Do not attempt to operate the trimmer whilst it is out of the machine or attempt to by-pass the safety switch.
- Do not attempt to cut corners in any part of the welding cycle.

# Connecting PE using a **FLANGE**

SlimFlange is a unique steel reinforced flange adaptor that allows bore-size-for-size jointing of a PE pipe to a metal flange.

## SLIMFLANGE®

Compact, lightweight yet strong, it eliminates the usual need to upsize valves or other metal fittings, benefitting installers with the faster more effective installations.

## NO UPSIZING

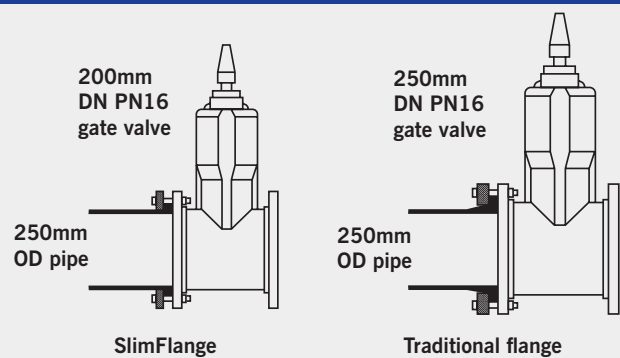

A 250mm SlimFlange connects 250mm OD (outside diameter) PE pipe directly to a 200mm DN PN16 valve. A traditional 250mm PE flange requires a 250mm ID (internal diameter) PN16 valve for bolting to match

## UNIQUE SOLUTION

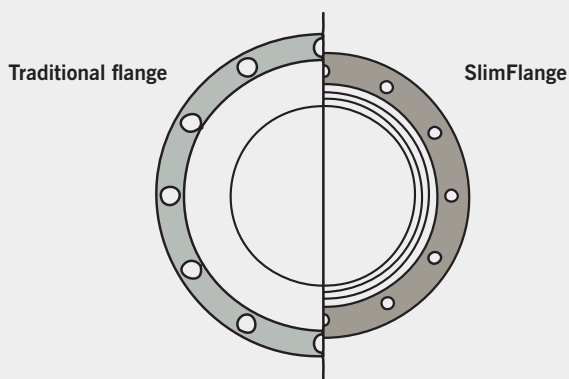

The SlimFlange has the same size bore as a traditional PE Flange, but has a smaller backing ring bolt circle diameter.

## NO SAFETY COMPROMISE

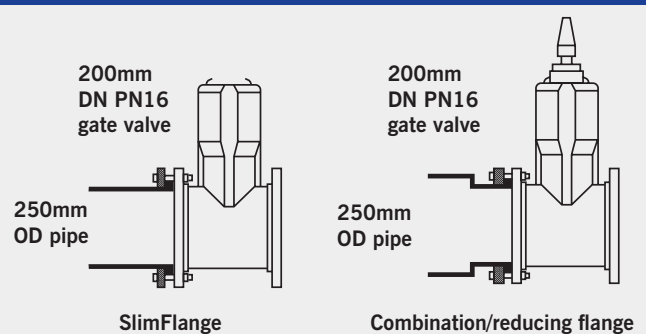

SlimFlange does not lead to loss of strength, unlike PE 'combination' flanges. Size-for-size capability is not achieved by temporary PE bore reduction, which weakens the fitting and increases the potential for blockage.

## FEATURES

- No need for upsizing metal fittings, or for PE bore reduction
- Fully end load bearing fitting
- Reduced size and weight
- Loose backing ring for flexible installation

## BENEFITS

- Cost savings from bore size-for-size connections
- Reduced installation costs
- Smooth bore to maintain full flow capacity
- Improved sealing performance against leaks

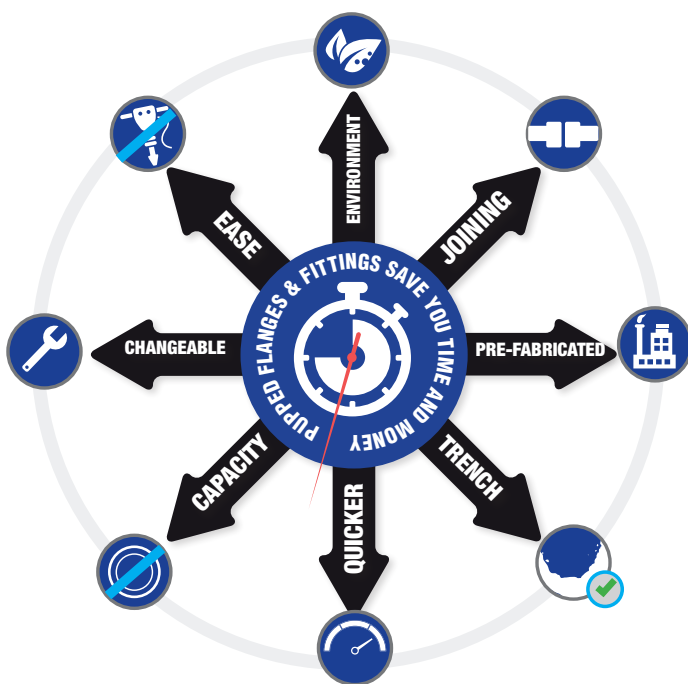

## CONNECTING PE TO OTHER MATERIALS

When joining PE to other materials it is important to remember PE works on an outside diameter and the wall thickness will vary depending on the SDR.

Ensure the nominal bores are taken into consideration when sizing flange adaptors to make a connection.

Since PE are end-load bearing, precautions must be taken when a connection is made to pipe of another material.

To prevent pull-out of any non end-load bearing joints, the transition may need to be externally harnessed or anchored/thrust blocked.

## BOLTING

For PE diameters above 180mm, it is recommended that two operators work simultaneously on diametrically opposite bolts where possible.

To guarantee subsequent leak tightness, final torquing should be repeated after the assembly has been allowed to relax for an hour or so.

Evenness of tightening is as important as final torque values – see table below.

This table is suitable for SDR 11 & SDR 17.6 pipe made from PE100 or PE80.

### Typical bolting torques for flanges (PE to PE or PE to metal flanges)

Standard Flanges				SlimFlanges or Special Flanges		
Nominal PE size (mm)	Nominal Iron size (mm)	Bolting	Torque (Nm) ±10%	Nominal Iron size (mm)	Bolting	Torque (Nm) ±10%
63	50	M16x4	35	-	-	-
90	80	M16x8	35	-	-	-
125	100	M16x8	35	-	-	-
180	150	M20x8	60	-	-	-
200	200	M20x12	80	-	-	-
225	200	M20x12	80	-	-	-
250	250	M24x12	100	200	M20x12	60
280	250	M24x12	100	-	-	-
315	300	M24x12	120	250	*M20x12	70
355	350	M24x16	150	300	M24x12	120
400	400	M27x16	200	350	M24x16	150
450	450	M27x20	250	400	M27x16	200
500	500	M30x20	300	450	M27x20	250
560	600	M33x20	350	500	M30x20	300
630	600	M33x20	400	500	M30x20	300
710	700	M33x24	400	600	M33x20	400
800	800	M36x24	450	700	M33x24	400
900	900	M36x28	450	800	M36x24	450
1000	1000	M39x28	500	900	M36x28	450
1200	1200	M54x32	550	1000	M39x28	500

\*Non standard bolt size

# Product range OVERVIEW

## PRODUCT MARKING

All Pipes and fittings should be used in order of delivery and to assist stock location.

## GPS PIPE MARKING

As a minimum requirement, the following Information is marked indelibly and linearly at intervals along the pipe:

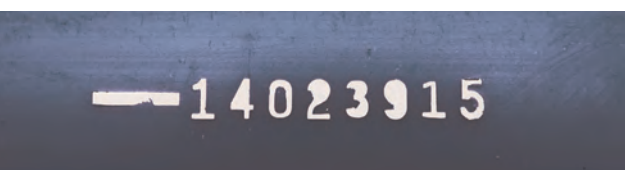
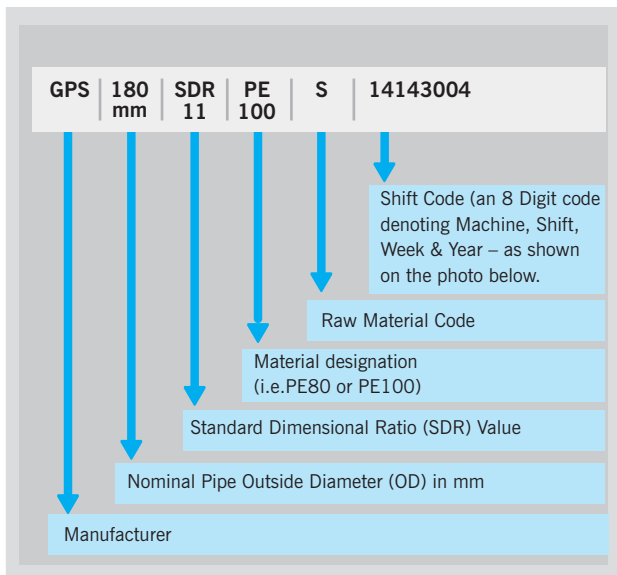

Shift code for a PE100 pipe

GPS pipe is also marked with the name of any industry standard to which it conforms.

Gas pipe also carries reference to the bar rating of the pipe (usually after the OD) and is marked at three separate intervals within the coding with the word Gas for high visibility and identification purposes.







## ELECTROFUSION FITTING MARKINGS

Where applicable, most fittings incorporate the following information on the outer surface, either moulded into the product or on the barcode label:

- Material Designation – PE100 or PE80
- Standard Dimensional Ratio (SDR) of Fitting
- SDR Fusion Range (maximum/minimum)
- Nominal Size (mm)
- Fusion Time (seconds)
- Cooling Time (minutes)
- Name and Trademark

Electrofusion fittings product labels also incorporate traceability barcodes to trace the relevant production records. These codes can be read by any ECU with a traceability option.



Product Range Overview	Description	Standards/ Approvals	Material	Size Range	Page
<b>EXCEL BLACK PIPE</b> 	HDPE pipe for potable water supply below ground	EN 12201-2	Polyethylene	75mm - 1200mm	32
<b>PE80 BLACK PIPE</b> 	MDPE pipe for potable water supply below ground	EN 12201-2	Polyethylene	20mm - 63mm	32
<b>MECHANICAL FITTINGS</b> 	Mechanical compression fittings for mechanical jointing without the need for pipe preparation or welding	WRAS WIS 4-24-01 Type 1 WIS 4-32-19	Stainless steel Rilsan coated steel	63mm – 180mm	44
<b>FRIALEN ELECTROFUSION FITTINGS</b> 	Electrofusion fittings with a bar coding system for rapid and convenient jointing	EN 12201-3	Polyethylene	20mm - 1200mm	50
<b>SPIGOT FITTINGS</b> 	Complete range of long spigot fittings suitable for Electrofusion and Butt Fusion	EN 12201-3	Polyethylene	32m - 355mm	66
<b>PUPPED FITTINGS</b> 	Extended spigots suitable for Electrofusion and Butt Fusion jointing	EN 12201-3	Polyethylene	90mm - 1200mm	76
<b>ACCESSORIES</b> 	A range of accessories available	–	–	–	88

### OTHER FITTING MARKINGS

All GPS fittings manufactured within a specific batch are marked with an identification number, unique to that batch.

This unique number consists of either 5 or 7 digits, which can be interpreted as follows on the table below:

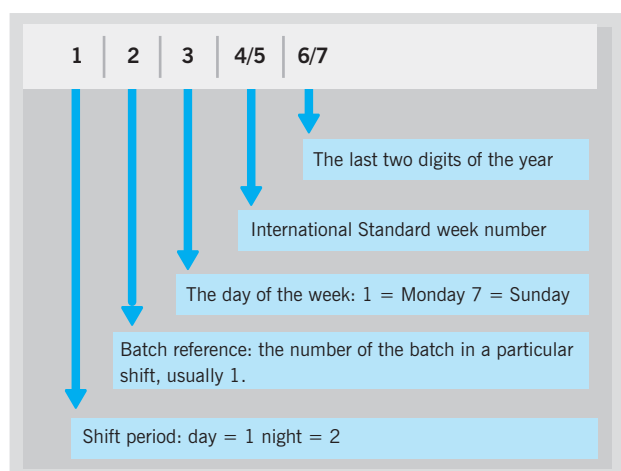

## DID YOU KNOW?

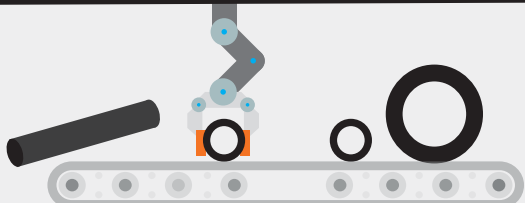

**Other diameters, SDRs and lengths can be made to order subject to a minimum order value**





### PE80 BLACK PIPE

#### FEATURES & BENEFITS

- Solid black PE80 for diameters from 20mm to 63mm
- Available in standard SDR 11
- Standard stick length 6m for 50mm and 63mm
- Standard coil lengths of 25m, 50m, and 100m (*Other lengths are available on request*)
- Compatible with GPS' portfolio of fittings
- Kitemarked to BS EN 12201 (KM508224)

Kitemarked to  
**BS EN 12201**  
(KM508224)

### EXCEL BLACK PIPE

#### FEATURES & BENEFITS

- Extruded black PE100 pipe
- Available in sizes from 75mm to 1200mm
- Available in standard SDRs' 11/17/21/26
- Standard stick lengths 6m and 12m (*straight lengths up to 18 metres available on request*)
- Compatible with GPS' existing portfolio of fittings
- Kitemarked to BS EN 12201 (KM508224)

Kitemarked to  
**BS EN 12201**  
(KM508224)

*Note:* Other diameters, SDRs and lengths can be made to order subject to a minimum order value.  
Please contact sale office for further information.



# BLACK PIPE FOR RAW WATER AND SEWAGE

## PIPE DIMENSIONS (BS EN 12201-2)

Size (mm)	SDR 11					SDR 17				SDR 21				SDR 26			
	12.5 BAR					-				-				-			
	16 BAR					10 BAR				8 BAR				6 BAR			
Max OD (mm)	Min t (mm)	Max t (mm)	Mean Weight (kg/m)	Mean Bore (mm)	Min t (mm)	Max t (mm)	Mean Weight (kg/m)	Mean Bore (mm)	Min t (mm)	Max t (mm)	Mean Weight (kg/m)	Mean Bore (mm)	Min t (mm)	Max t (mm)	Mean Weight (kg/m)	Mean Bore (mm)	
20*	20.3	2.0	2.3	0.1	15.2	-	-	-	-	-	-	-	-	-	-	-	-
25	25.3	2.3	2.7	0.2	20.2	-	-	-	-	-	-	-	-	-	-	-	-
32	32.3	3.0	3.4	0.3	25.8	-	-	-	-	-	-	-	-	-	-	-	-
40	40.4	3.7	4.2	0.4	32.3	-	-	-	-	-	-	-	-	-	-	-	-
50	50.4	4.6	5.2	0.7	40.4	-	-	-	-	-	-	-	-	-	-	-	-
63	63.4	5.8	6.5	1.0	50.9	-	-	-	-	-	-	-	-	-	-	-	-
75	75.5	6.8	7.6	1.5	60.9	4.5	5.1	1.0	65.7	3.6	4.1	0.8	67.6	-	-	-	-
90	90.6	8.2	9.2	2.1	72.9	5.4	6.1	1.5	78.8	4.3	4.9	1.2	81.1	3.5	4.0	1.0	82.8
110	110.7	10.0	11.1	3.2	89.3	6.6	7.4	2.2	96.4	5.3	6.0	1.8	99.1	4.2	4.8	1.4	101.4
125	125.8	11.4	12.7	4.1	101.3	7.4	8.3	2.8	109.7	6.0	6.7	2.3	112.7	4.8	5.4	1.9	115.2
160	161.0	14.6	16.2	6.7	129.7	9.5	10.6	4.6	140.4	7.7	8.6	3.7	144.2	6.2	7.0	3.1	147.3
180	181.1	16.4	18.2	8.5	146.0	10.7	11.9	5.8	158.0	8.6	9.6	4.7	162.4	6.9	7.7	3.8	166.0
200	201.2	18.2	20.2	10.5	162.2	11.9	13.2	7.1	175.5	9.6	10.7	5.8	180.3	7.7	8.6	4.7	184.3
225	226.4	20.5	22.7	13.3	182.5	13.4	14.9	9.0	197.4	10.8	12.0	7.4	202.9	8.6	9.6	5.9	207.5
250	251.5	22.7	25.1	16.3	203	14.8	16.4	11.1	219.6	11.9	13.2	9.0	225.7	9.6	10.7	7.4	230.5
280	281.7	25.4	28.1	20.5	227.4	16.6	18.4	13.9	245.9	13.4	14.9	11.4	252.6	10.7	11.9	9.2	258.3
315	316.9	28.6	31.6	25.9	255.8	18.7	20.7	17.6	276.6	15.0	16.6	14.3	284.4	12.1	13.5	11.7	290.4
355	357.2	32.2	35.6	32.9	288.3	21.1	23.4	22.4	311.6	16.9	18.7	18.2	320.5	13.6	15.1	14.8	327.4
400	402.4	36.3	40.1	41.8	324.6	23.7	26.2	28.3	351.3	19.1	21.2	23.2	360.9	15.3	17.0	18.7	368.9
450	452.7	40.9	45.1	52.9	365.4	26.7	29.5	35.9	395.2	21.5	23.8	29.3	406.1	17.2	19.1	23.7	415.1
500	503.0	45.4	50.1	65.2	405.8	29.7	32.8	44.3	439.0	23.9	26.4	36.1	451.2	19.1	21.2	29.2	461.2
560	563.4	50.8	56	81.7	454.9	33.2	36.7	55.5	491.8	26.7	29.5	45.2	505.5	21.4	23.7	36.6	516.6
630	633.8	57.2	63.1	103.6	511.4	37.4	41.3	70.3	553.2	30.0	33.1	57.1	568.8	24.1	26.7	46.4	581.1
710	716.4	64.5	71.1	131.5	577.6	42.1	46.5	89.1	624.6	33.9	37.4	72.6	641.9	27.2	30.1	58.9	655.9
800	807.2	-	-	-	-	47.4	52.3	113.1	703.9	38.1	42.1	92.1	723.4	30.6	33.8	74.7	739.2
900	908.1	-	-	-	-	53.3	58.8	142.9	792.0	42.9	47.3	116.4	813.9	34.4	38.3	94.8	831.4
1000	1009.0	-	-	-	-	59.3	65.4	176.5	879.8	47.7	52.6	143.8	904.2	38.2	42.2	116.5	924.1
1200	1210.8	-	-	-	-	71.1	78.4	254.5	1055.9	57.2	63.1	207.4	1085.1	45.9	50.6	167.8	1108.9

\* SDR9 only

## STRAIGHT LENGTHS

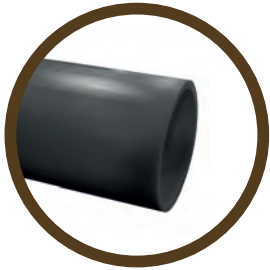

SDR 11			
Size/OD (mm)	Material	Length (m)	Product Code
50	PE80	6	50 512 310
63	PE80	6	50 513 311
75	PE100	6	40 512 313
		12	40 527 313
90	PE100	6	40 512 314
		12	40 527 314
110	PE100	6	40 512 315
		12	40 527 315
125	PE100	6	40 512 317
		12	40 527 317
160	PE100	6	40 512 318
		12	40 527 318
180	PE100	6	40 512 319
		12	40 527 319
200	PE100	6	40 512 320
		12	40 527 320
225	PE100	6	40 512 321
		12	40 527 321
250	PE100	6	40 512 322
		12	40 527 322
280	PE100	6	40 512 323
		12	40 527 323
315	PE100	6	40 512 324
		12	40 527 324
355	PE100	6	40 512 325
		12	40 527 325
400	PE100	6	40 512 326
		12	40 527 326
450	PE100	6	40 512 327
		12	40 527 327
500	PE100	6	40 512 328
		12	40 527 328
560	PE100	6	40 512 329
		12	40 527 329
630	PE100	6	40 512 330
		12	40 527 330
710	PE100	6	21 512 330
		12	21 527 330

**LENGTHS & BUNDLES**

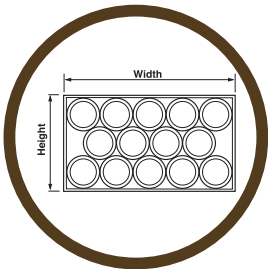

SDR 11					
Size/OD (mm)	Length (m)	No / Bundle	Width (mm)	Height (mm)	Approx Weight (kg)
50	6	360	1238	750	1402
63	6	210	1238	750	1334
75	6	160	1238	845	1392
	12				2784
90	6	100	1188	795	1306
	12				2604
110	6	67	1238	795	1302
	12				2597
125	6	50	1238	750	1256
	12				2504
160	6	33	1238	795	1360
	12				2712
180	6	22	1188	730	1144
	12				2281
200	6	18	1238	845	1156
	12				2305
225	6	18	1238	897	1462
	12				2868
250	6	5	1112	770	1099
	12				2191
280	6	11	1238	845	1375
	12				2741
315	6	8	1060	947	1264
	12				2528
355	6	8	1188	1049	1608
	12	3	1065	480	1171
400	6	3	1200	510	763
	12				1521
450	6	3	1350	560	965
	12				1926
500	6	2	1000	610	793
	12				1584
560	6	2	1120	670	990
	12				1977
630	6	2	1260	740	1245
	12				2487
710	6	2	1420	820	1578
	12				3156

*Note:* due to continuous development, bundle sizes and weights may vary from that shown

## COILS

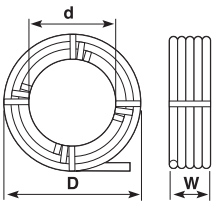

SDR 11							
Size/OD (mm)	Material	Length (m)	Product Code	d (mm)	D (mm)	W (mm)	Approx. Weight (kg)
20*	PE80	25	50 558 306	600	750	120	3.3
		50	50 559 306		790	140	6.5
		100	50 560 306		860	180	13.0
		150	50 561 306		860	250	18.5
25	PE80	25	50 558 307	600	830	90	4.3
		50	50 559 307		820	170	8.4
		100	50 560 307		890	200	16.7
		150	50 561 307		890	290	25.1
32	PE80	25	50 558 308	700	960	100	6.8
		50	50 559 308		1020	150	13.9
		100	50 560 308		1090	220	27.8
		150	50 561 308		1090	310	41.7
50	PE80	25	50 558 310	1300	1500	170	16.2
		50	50 559 310		1800	170	32.5
		100	50 560 310		1800	260	66.6
		150	50 561 310		2100	260	99.9
63	PE80	25	50 558 311	1300	1600	190	25.8
		50	50 559 311		1780	190	52.7
		100	50 560 311		1960	280	105.3
		150	50 561 311		2130	280	158.0
75	PE100	50	21 559 312	1500	1900	310	73.0
		100	21 560 312		2300	310	145.0
90	PE100	50	40 559 313	1800	2360	360	106.0
		100	40 560 313		2540	450	212.0
110	PE100	50	40 559 314	2500	2700	450	160.0
		100	40 560 314		2900	570	318.0
125	PE100	50	40 559 315	2500	3000	500	204.0
		100	40 560 315		3250	560	408.0
160	PE100	50	40 559 317	3000	3900	490	337.0
		100	40 560 317		3900	650	670.0
180	PE100	50	40 559 318	3000	3800	560	422.5
		100	40 560 318		4000	900	845.0

\* SDR 9 only

**STRAIGHT LENGTHS**

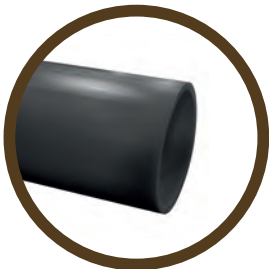

SDR 17			
Size/OD (mm)	Material	Length (m)	Product Code
90	PE100	6	40 506 313
		12	40 507 313
110	PE100	6	40 506 314
		12	40 507 314
125	PE100	6	40 506 315
		12	40 507 315
160	PE100	6	40 506 317
		12	40 507 317
180	PE100	6	40 506 318
		12	40 507 318
200	PE100	6	40 506 319
		12	40 507 319
225	PE100	6	40 506 320
		12	40 507 320
250	PE100	6	40 506 321
		12	40 507 321
280	PE100	6	40 506 322
		12	40 507 322
315	PE100	6	40 506 323
		12	40 507 323
355	PE100	6	40 506 324
		12	40 507 324
400	PE100	6	40 506 325
		12	40 507 325
450	PE100	6	40 506 326
		12	40 507 326
500	PE100	6	40 506 327
		12	40 507 327
560	PE100	6	40 506 328
		12	40 507 328
630	PE100	6	40 506 329
		12	40 507 329
710	PE100	6	40 506 330
		12	40 507 330
800	PE100	6	40 506 332
		12	40 507 332
900	PE100	6	40 506 333
		12	40 507 333
1000	PE100	6	40 506 334
		12	40 507 334
1200	PE100	6	40 506 335
		12	40 507 335

## LENGTHS & BUNDLES

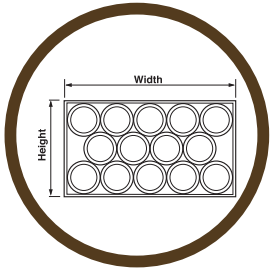

SDR 17					
Size/OD (mm)	Length (m)	No / Bundle	Width (mm)	Height (mm)	Approx Weight (kg)
90	6	100	1188	795	901
	12				1795
110	6	67	1238	795	896
	12				1782
125	6	50	1238	750	854
	12				1697
160	6	33	1238	795	925
	12				1843
180	6	22	1188	730	782
	12				1556
200	6	18	1238	845	797
	12				1586
225	6	18	1238	897	999
	12				1989
250	6	5	1112	770	748
	12				1490
280	6	11	1238	845	940
	12				1872
315	6	8	1060	947	862
	12				1718
355	6	8	1188	1049	1099
	12				2152
400	6	3	1200	510	519
	12				1032
450	6	3	1350	560	655
	12				1306
500	6	2	1000	610	539
	12				1075
560	6	2	1120	670	655
	12				1307
630	6	2	1260	740	840
	12				1678
710	6	2	1420	820	1064
	12				2124
800	6	1	800	800	670
	12				1339
900	6	1	900	900	846
	12				1692
1000	6	1	1000	1000	1063
	12				2125
1200	6	1	1200	1200	1527
	12				3054

Note: due to continuous development, bundle sizes and weights may vary from that shown

**COILS**

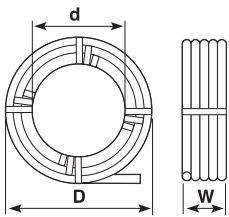

SDR 17							
Size/OD (mm)	Material	Length (m)	Product Code	d (mm)	D (mm)	W (mm)	Approx. Weight (kg)
75	PE100	50	40 548 312	1800	2200	310	51.0
		100	40 549 312		2500	310	102.0
90	PE100	50	40 548 313	2500	3100	270	69.5
		100	40 549 313		3300	360	139.0
110	PE100	50	40 548 314	2500	2800	450	104.0
		100	40 549 314		3100	570	206.0
125	PE100	50	40 548 315	2500	3500	400	133.0
		100	40 549 315		3750	500	266.0
160	PE100	50	40 548 317	3000	3900	490	220.0
		100	40 549 317		3900	650	438.0
180	PE100	50	40 548 318	3000	3400	560	274.5
		100	40 549 318		4000	900	549.0

## STRAIGHT LENGTHS

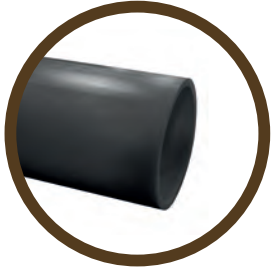

SDR 21			
Size/OD (mm)	Material	Length (m)	Product Code
160	PE100	6	40 519 317
		12	40 539 317
180	PE100	6	40 519 318
		12	40 539 318
200	PE100	6	40 519 319
		12	40 539 319
225	PE100	6	40 519 320
		12	40 539 320
250	PE100	6	40 519 321
		12	40 539 321
280	PE100	6	40 519 322
		12	40 539 322
315	PE100	6	40 519 323
		12	40 539 323
355	PE100	6	40 519 324
		12	40 539 324
400	PE100	6	40 519 325
		12	40 539 325
450	PE100	6	40 519 326
		12	40 539 326
500	PE100	6	40 519 327
		12	40 539 327
560	PE100	6	40 519 328
		12	40 539 328
630	PE100	6	40 519 329
		12	40 539 329
710	PE100	6	40 519 330
		12	40 539 330
800	PE100	6	40 519 332
		12	40 539 332
900	PE100	6	40 519 333
		12	40 539 333
1000	PE100	6	40 519 334
		12	40 539 334
1200	PE100	6	40 519 335
		12	40 539 335



**LENGTHS & BUNDLES**

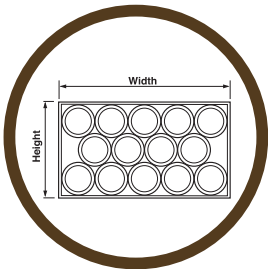

SDR 21					
Size/OD (mm)	Length (m)	No / Bundle	Width (mm)	Height (mm)	Approx Weight (kg)
160	6	33	1238	795	733
	12				1465
180	6	22	1188	730	634
	12				1276
200	6	18	1238	845	648
	12				1296
225	6	18	1238	897	811
	12				1631
250	6	5	1112	770	614
	12				1234
280	6	11	1238	845	774
	12				1540
315	6	8	1060	947	706
	12				1386
355	6	8	1188	1049	896
	12				1797
400	6	3	1200	510	424
	12				843
450	6	3	1350	560	534
	12				1065
500	6	2	1000	610	440
	12				1096
560	6	2	1120	670	549
	12				1096
630	6	2	1260	740	695
	12				1733
710	6	2	1420	820	880
	12				1757
800	6	1	800	800	549
	12	1			1104
900	6	1	900	900	699
	12				1398
1000	6	1	1000	1000	863
	12				1726
1200	6	1	1200	1200	1225
	12				2451

*Note:* due to continuous development, bundle sizes and weights may vary from that shown

## STRAIGHT LENGTHS

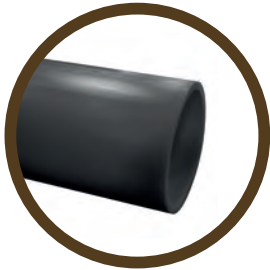

SDR 26			
Size/OD (mm)	Material	Length (m)	Product Code
160	PE100	6	40 518 317
		12	40 528 317
180	PE100	6	40 518 318
		12	40 528 318
200	PE100	6	40 518 319
		12	40 528 319
225	PE100	6	40 518 320
		12	40 528 320
250	PE100	6	40 518 321
		12	40 528 321
280	PE100	6	40 518 322
		12	40 528 322
315	PE100	6	40 518 323
		12	40 528 323
355	PE100	6	40 518 324
		12	40 528 324
400	PE100	6	40 518 325
		12	40 528 325
450	PE100	6	40 518 326
		12	40 528 326
500	PE100	6	40 518 327
		12	40 528 327
560	PE100	6	40 518 328
		12	40 528 328
630	PE100	6	40 518 329
		12	40 528 329
710	PE100	6	40 518 330
		12	40 528 330
800	PE100	6	40 518 332
		12	40 528 332
900	PE100	6	40 518 333
		12	40 528 333
1000	PE100	6	40 518 334
		12	40 528 334
1200	PE100	6	40 518 335
		12	40 528 335

SDR26 pipe can be suitable for low or zero pressure applications in favourable ground conditions. Please contact our Technical Support Department for further information

Other diameters, SDRs and lengths can be made to order subject to a minimum order value – please contact our Sales Office for further information

GPS pipes manufactured to EN12201-2 are capable of withstanding repeated transient surge pressures of up to twice the rated pressure of the pipe.

**LENGTHS & BUNDLES**

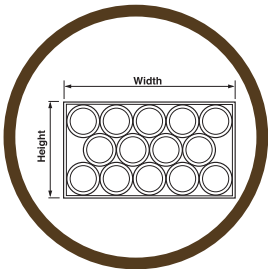

SDR 26					
Size/OD (mm)	Length (m)	No / Bundle	Width (mm)	Height (mm)	Approx Weight (kg)
160	6	33	1238	795	630
	12				1251
180	6	22	1188	730	524
	12				1041
200	6	18	1238	845	540
	12				1080
225	6	18	1238	897	669
	12				1331
280	6	11	1238	845	632
	12				1255
315	6	8	1060	947	580
	12				1153
355	6	8	1188	1049	734
	12				1460
400	6	3	1200	510	347
	12				863
450	6	3	1350	560	436
	12				917
500	6	2	1000	610	359
	12				892
560	6	2	1120	670	449
	12				894
630	6	2	1260	740	565
	12				1127
710	6	2	1420	820	716
	12				1434
800	6	1	800	800	447
	12				894
900	6	1	900	900	572
	12				114
1000	6	1	1000	1000	704
	12				1408
1200	6	1	1200	1200	993
	12				1986

*Note:* due to continuous development, bundle sizes and weights may vary from that shown

# MECHANICAL FITTINGS

MECHANICAL FITTINGS FOR POTABLE & NON-POTABLE WATER

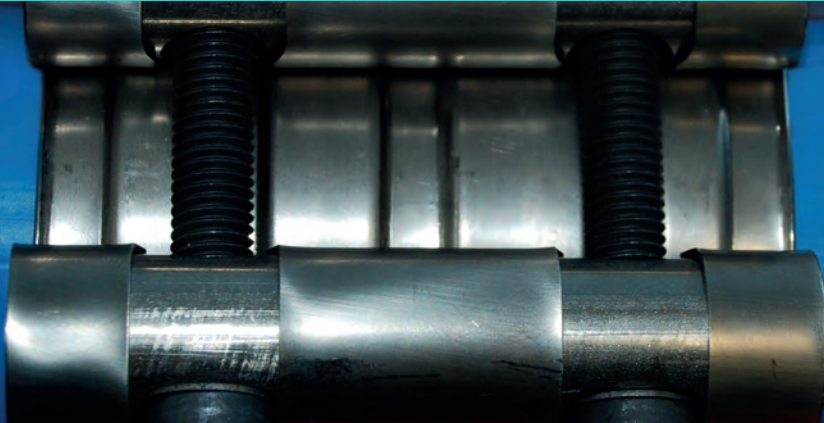

## FEATURES & BENEFITS

- Fast and easy all weather jointing by a single installer: no need for elastomeric seals, pipe end preparation or welding.
- Only a torque wrench with an Allen (hex) bit socket is required
- No need for specialist tooling (eg. hydraulic pump) or external power supply – reduced health & safety risk
- Can be installed in the tightest of spaces.
- Supplied ready to install, as a full set of Rilsan coated steel liner insert and corrosion resistant stainless steel outer shells
- The shell mechanically swages PE pipe onto the insert liner grooves to give a fully end load bearing joint (WIS 4-24-01 Type 1)
- Lightweight and with a low profile

## DID YOU KNOW?

**By using mechanical fittings, up to 70% installation time can be saved compared to traditional methods**



## OUTER SHELLS



Size (mm)	DV (mm)	KV (mm)	Y (mm)	Hex Size (mm)	Bolts	Torque (NM)
63	67	95	48	10	M12	50
90	97	121	48	10	M12	60
110	117	140	55	10	M12	60
125	132	156	55	10 / 14*	M12 / M16*	60 / 120*
160	168	189	55	14	M16	150
180	188	217	55	14	M16	160

\* Bolt M16 FOR SDR11

Mechanical Fittings are supplied as a full set of liner insert and outer shell(s).  
Weights shown are for the complete product.

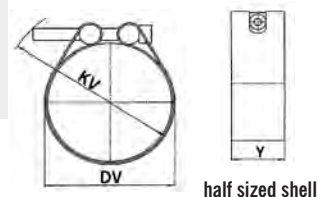

half sized shell

## COUPLERS

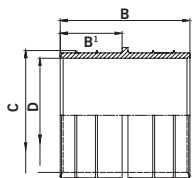

Size (mm)	SDR	Product Code	B (mm)	B1 (mm)	C (mm)	D (mm)	Weight (kg)
63	11	SM 110 311	95	45	50	41	1.6
90	11	SM 100 313	95	45	71	62	2
	17	SM 109 313	95	45	77	67	2.1
110	11	SM 100 314	110	53	88	76	2.6
	17	SM 109 314	110	53	95	82	2.7
125	11	SM 100 315	110	53	100	87	3.1
	17	SM 109 315	110	53	108	95	3.0
160	11	SM 100 317	110	53	128	114	4.4
	17	SM 109 317	110	53	139	125	4.3
180	11	SM 100 318	110	53	144	127	4.8
	17	SM 109 318	110	53	156	139	5.1

Supplied as a set with 1 x liner and 2 x half shells

## REPAIR COUPLERS

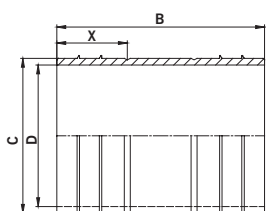

Size (mm)	SDR	Product Code	B (mm)	X (mm)	C (mm)	D (mm)	Weight (kg)
63	11	SM 246 311	195	48	50	40	1.9
90	11	SM 246 313	195	48	71	61	2.6
	17	SM 245 313	195	48	77	67	2.7
110	11	SM 246 314	210	55	88	75	3.0
	17	SM 245 314	210	55	95	82	3.1
125	11	SM 246 315	210	55	100	86	4.0
	17	SM 245 315	210	55	108	94	4.4
160	11	SM 246 317	210	55	128	114	5.8
	17	SM 245 317	210	55	139	125	6.1
180	11	SM 246 318	210	55	144	127	6.7
	17	SM 245 318	210	55	156	139	7.1

Supplied as a set with 1 x liner and 2 x half shells. Other repair liner lengths may be available on request.

## REDUCERS

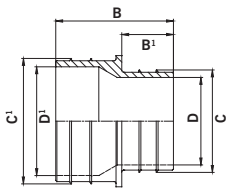

Size (mm)	SDR	Product Code	B (mm)	B1 (mm)	C (mm)	C1 (mm)	D (mm)	D1 (mm)	Weight (kg)
90 x 63	11	SM 441 459	95	45	50	71	41	62	2.0
110 x 90	11	SM 441 483	103	53 / 46	71	88	62	76	2.5
	17	SM 440 483	103	45	77	95	67	82	2.6
125 x 110	11	SM 441 493	110	53	88	100	76	87	3.3
	17	SM 440 493	110	53	88	108	76	95	3.2
160 x 125	11	SM 441 504	110	53	100	128	87	114	4.8
	17	SM 440 504	110	53	108	139	95	125	5.8
180 x 125	17	SM 440 505	110	53	108	156	95	139	6.2

Consists of 1 x reducing liner and 2 x half sized shells.

## 90° ELBOWS

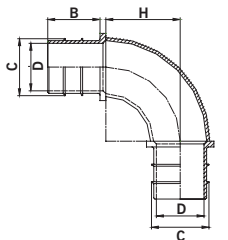

Size (mm)	SDR	Product Code	B (mm)	C (mm)	D (mm)	H (mm)	Weight (kg)
63	11	SM 209 311	45	50	41	69	2.0
90	11	SM 210 313	45	71	62	97	3.2
	17	SM 208 313	45	77	67	100	3.3
110	11	SM 210 314	53	88	76	122	3.7
	17	SM 208 314	53	95	82	122	3.8
125	11	SM 210 315	53	100	87	138	6.1
	17	SM 208 315	53	108	95	147	6.0
160	11	SM 210 317	53	128	114	180	9.3
	17	SM 208 317	53	139	125	195	8.3
180	11	SM 210 318	53	144	127	200	10.6
	17	SM 208 318	53	156	139	226	10.8

Consists of 1 x elbow liner and 2 x half sized shells.

## 45° ELBOWS

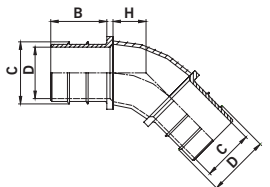

Size (mm)	SDR	Product Code	B (mm)	C (mm)	D (mm)	H (mm)	Weight (kg)
63	11	SM 215 311	45	50	41	32	1.8
90	11	SM 216 313	45	71	62	43	2.3
	17	SM 214 313	45	77	67	44	2.4
110	11	SM 216 314	53	88	76	53	3.1
	17	SM 214 314	53	95	82	54	3.2
125	11	SM 216 315	53	100	87	60	4.9
	17	SM 214 315	53	108	95	64	4.9
160	11	SM 216 317	53	128	114	78	7.4
	17	SM 214 317	53	139	125	84	7.7
180	11	SM 216 318	53	144	127	89	8.1
	17	SM 214 318	53	156	139	94	8.2

Consists of 1 x elbow liner and 2 x half sized shells.

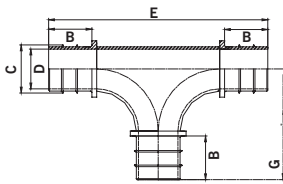
**EQUAL TEES**

Size (mm)	SDR	Product Code	B (mm)	C (mm)	D (mm)	E (mm)	G (mm)	Weight (kg)
63	11	SM 221 311	45	50	41	214	62	3.0
90	11	SM 222 313	45	71	62	252	81	5.3
	17	SM 220 313	45	77	67	252	81	5.4
110	11	SM 222 314	53	88	76	287	91	7.4
	17	SM 220 314	53	95	82	287	91	7.5
125	11	SM 222 315	53	100	87	315	105	7.5
	17	SM 220 315	53	108	95	325	110	8.9
160	11	SM 222 317	53	128	114	355	125	11.6
	17	SM 220 317	53	139	125	363	129	16.1
180	11	SM 222 318	53	144	127	363	129	12.2
	17	SM 220 318	53	156	139	401	148	19

Consists of 1 x equal tee liner and 3 x half sized shells.

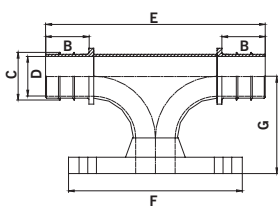
**FLANGED BRANCH TEES**

Size (mm)	SDR	Product Code	Bolts, Qty	Flange Torque (NM ± 10%)	B (mm)	C (mm)	D (mm)	E (mm)	F (mm)	G (mm)	Weight (kg)
90 x DN80 PN16	11	SM 351 313	8 x M16	70	45	71	62	252	200	176	8.9
	17	SM 363 313	8 x M16	70	45	77	67	252	200	176	9.0
110 x DN80 PN16	11	SM 351 314	8 x M16	70	53	88	76	287	200	136	9.5
	17	SM 363 314	8 x M16	70	53	95	82	287	200	136	9.6
125 x DN80 PN16	17	SM 363 315	8 x M16	70	53	108	95	287	200	136	12.0
160 x DN80 PN16	17	SM 363 317	8 x M16	70	53	139	125	287	200	161	16.2
180 x DN80 PN16	17	SM 363 318	8 x M16	70	53	156	139	325	200	174	19.6
90 x DN100 PN16	11	SM 352 313	8 x M16	80	45	71	62	252	220	178	9.1
	17	SM 364 313	8 x M16	80	45	77	67	252	220	178	9.2
110 x DN100 PN16	11	SM 352 314	8 x M16	80	53	88	76	287	220	188	9.7
	17	SM 364 314	8 x M16	80	53	95	82	287	220	188	9.8
125 x DN100 PN16	17	SM 364 315	8 x M16	80	53	108	95	325	220	157	12.2
160 x DN100 PN16	17	SM 364 317	8 x M16	80	53	139	125	325	220	168	16.9
180 x DN100 PN16	17	SM 364 318	8 x M16	80	53	156	139	325	220	182	20.0
160 x DN150 PN16	17	SM 365 317	8 x M20	120	53	139	125	363	285	229	20.4
180 x DN150 PN16	17	SM 365 318	8 x M20	120	53	156	139	401	285	198	23.4

Consists of 1 x flanged branch tee liner and 2 x half sized shells.

The information given for bolting torque values are for metal to metal connections.

Flange bolts and gaskets are not included.

Drilled to BS EN 1092-1:2007 Table 13.

## STUB FLANGE ADAPTORS

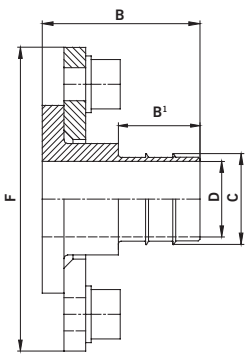

Size (mm)	SDR	Product Code	Bolts, Qty	Flange Torque (NM ± 10%)	B (mm)	C (mm)	D (mm)	B1 (mm)	F (mm)	Weight (kg)
63 x DN50 PN16	11	SM 227 311	M16 x 4	60	83	50	41	45	165	2.4
63 x DN80 PN16	11	SM 228 311	M16 x 8	60	85	50	41	45	202	4.1
90 x DN80 PN16	11	SM 228 313	M16 x 8	70	85	71	62	45	202	3.8
	17	SM 226 313	M16 x 8	70	85	77	67	45	200	3.9
110 x DN100 PN16	11	SM 228 314	M16 x 8	80	93	88	76	53	220	4.0
	17	SM 226 314	M16 x 8	80	93	95	82	53	218	5.0
125 x DN100 PN16	11	SM 228 315	M16 x 8	80	93	100	87	53	220	4.6
	17	SM 226 315	M16 x 8	80	93	108	95	53	220	4.2
160 x DN150 PN16	11	SM 228 317	M20 x 8	120	105	128	114	53	286	11.1
	17	SM 226 317	M20 x 8	120	105	139	125	53	286	10.2
180 x DN150 PN16	11	SM 228 318	M20 x 8	120	105	144	127	53	286	10.2
	17	SM 226 318	M20 x 8	120	105	156	139	53	286	9.0

Consists of 1 x stub flange liner, 1 x half sized shell and backing ring.  
 The information given for bolting torque values are for metal to metal connections.  
 Flange bolts and gaskets are not included.  
 Drilled to BS EN 1092-1:2007 Table 13.



**DUCK FOOT BENDS**

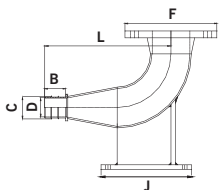
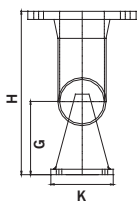

Size (mm)	SDR	Product Code	Bolts, Qty	Flange Torque (NM± 10%)	B (mm)	C (mm)	D (mm)	F (mm)	G (mm)	H (mm)	J (mm)	K (mm)	L (mm)	Weight (kg)
63 x DN80 PN16	11	SM 384 459	M16 x 8	70	45	50	41	200	135	167	152	90	275	9.4
90 x DN80 PN16	11	SM 384 313	M16 x 8	70	45	71	62	200	135	167	152	115	235	10.0
	17	SM 385 313	M16 x 8	70	45	77	67	200	135	167	152	115	190	10.1
110 x DN80 PN16	11	SM 384 314	M16 x 8	70	53	88	76	200	135	167	152	130	231	10.7
	17	SM 385 314	M16 x 8	70	53	95	82	200	135	167	152	130	178	10.8
125 x DN80 PN16	17	SM 385 484	M16 x 8	70	53	108	95	200	135	167	152	150	243	11.1
160 x DN80 PN16	17	SM 385 486	M16 x 8	70	53	139	125	200	135	167	152	180	310	16.2
180 x DN80 PN16	17	SM 385 487	M16 x 8	70	53	156	139	200	135	167	152	200	347	19.2

Consists of 1 x flanged bend, 1 x half sized shell and gasket.  
 The information given for bolting torque values are for metal to metal connections.  
 Flange bolts and gaskets are not included.  
 Drilled to BS EN 1092-1:2007 Table 13.



# FRIALEN SAFETY FITTINGS

ELECTROFUSION FITTINGS FOR POTABLE AND NON-POTABLE WATER



## FEATURES & BENEFITS

- Sizes from 20mm to 1200mm
- Comprehensive range of couplers, elbows and tapping tees
- 4mm terminal pins (adaptor pins are available)
- Premium quality Black PE100 materials used
- Exposed heating coil for consistent heat transfer
- Longer fusion zone for a stronger joint
- Frialen fittings offer superior jointing technology
- Designed with the needs of the installer in mind
- Focus on improving joint quality / customer outcomes
- Major innovator in electrofusion jointing technologies

Size	Fusion Zone Length (mm)		
	EN 1555-3	GIS/PL2-4	Frialen
90	13	28	41
110	15	32	48
125	16	35	46
160	20	42	52
180	21	46	63
200	23	46	63
225	26	48	71
250	33	50	68
280	35	50	56
315	39	50	78

## DID YOU KNOW?

The Frialen range of electrofusion couplers have been designed to address the 3 major causes of electrofusion joint failure:  
**Contamination, Ovality and Mis-alignment**



# ELECTROFUSION FITTINGS FOR POTABLE AND NON-POTABLE WATER

## COUPLERS – Removable Centre Stop

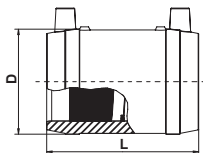

Size (mm)	SDR	Product Code	D (mm)	L (mm)	Weight (kg)	Fusion Time (Sec)	Cooling Time (mins)
20	11	FL 612 680	33	60	0.1	25	5
25	11	FL 612 681	37	78	0.1	30	5
32	11	FL 612 682	45	78	0.1	26	5
40	11	FL 612 683	54	86	0.1	46	7
50	11	FL 612 684	68	98	0.2	42	7
63	11	FL 612 685	82	110	0.2	36	7
75	11	FL 612 686	98	122	0.3	58	10
90	11	FL 612 687	114	138	0.4	85	10
110	11	FL 612 688	137	159	0.7	120	10
125	11	FL 612 689	156	172	1.0	225	15
140	11	FL 612 690	174	184	1.3	280	15
160	11	FL 612 691	199	190	1.8	360	20

Maximum continuous operating pressure SDR 11 - 16 bar water (EN 12201-3)

Manual fusion times are based on 39.5 volt fusion boxes

4.0mm terminal pins

## COUPLERS – Slideover SDR 11

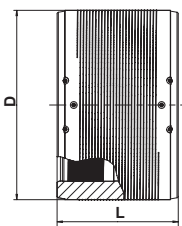

Size (mm)	SDR	Product Code	D (mm)	L (mm)	Weight (kg)	Fusion Time (Sec)	Cooling Time (mins)
180	11	FL 612 672	220	210	2.1	480	20
200	11	FL 612 673	247	220	2.8	550	20
225	11	FL 612 674	277	236	4.0	550	20
250	11	FL 612 675	315	246	5.8	620	30
280	11	FL 615 073	347	285	7.8	897	30
315	11	FL 612 670	390	300	10.1	1250	30
355	11	FL 615 074	445	300	14.6	1130	30
400	11	FL 615 075	500	320	20.8	750	40
450	11	FL 615 076	560	340	30.0	barcode read only	
500	11	FL 615 124	630	360	40.0	barcode read only	
560	11	FL 613 312	715	380	55.0	barcode read only	
	17	FL 615 706	630	380	24.2	barcode read only	
630	11	FL 616 269	810	420	79.6	barcode read only	
	17	FL 615 726	710	420	34.9	barcode read only	
710	11	FL 616 313	900	420	101.0	barcode read only	
	17	FL 615 994	800	420	47.5	barcode read only	
800	11	FL 616 314	1000	500	138.8	barcode read only	
	17	FL 616 290	900	500	65.9	barcode read only	
900	17	FL 616 345	1024	500	91.5	barcode read only	
1000*	17	FL 616 403	1130	610	128.0	barcode read only	
1200*	17	FL 616 416	1356	670	205.0	barcode read only	

Maximum continuous operating pressure SDR 11 - 16 bar water (EN 12201-3)

Maximum continuous operating pressure SDR 17 - 10 bar water (EN 12201-3)

Couplers from 400mm upwards are bifilament - have separate fusion zones

Couplers from 355mm upwards have external reinforcement

Manual fusion times are based on 39.5 volt fusion boxes

4.0mm terminal pins

\*Can only be installed using the FRIAMAT XL control box

## FRIAFIT COUPLERS – Slideover

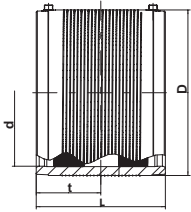

Size (mm)	SDR	Product Code	D (mm)	L (mm)	Weight (kg)	Fusion Time (Sec)	Cooling Time (mins)
110	17	FF 680 001	130	160	0.6	barcode read only	
125	17	FF 680 013	146	160	0.7	barcode read only	
160	17	FF 680 002	184	180	1.1	barcode read only	
180	17	FF 680 003	207	180	1.5	barcode read only	
200	17	FF 680 004	236	180	2.1	barcode read only	
225	17	FF 680 005	263	200	2.7	barcode read only	
250	17	FF 680 006	282	220	2.2	barcode read only	
280	17	FF 680 007	316	220	3.8	barcode read only	

Maximum continuous operating pressure SDR 17 - 10 bar water (EN 12201-3)  
4.0mm terminal pins

## COUPLERS – Slideover, SDR 7.4

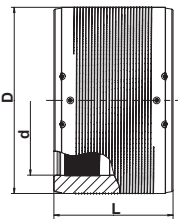

Size (mm)	SDR	Product Code	D (mm)	L (mm)	Weight (kg)	Fusion Time (Sec)	Cooling Time (mins)
90	7.4	FL 616 270	117	138	0.5	barcode read only	
110	7.4	FL 616 271	142	159	0.9	barcode read only	
125	7.4	FL 616 272	160	172	1.2	barcode read only	
140	7.4	FL 616 273	181	184	1.6	barcode read only	
160	7.4	FL 616 274	206	203	2.4	barcode read only	
180	7.4	FL 616 282	225	210	2.7	barcode read only	
200	7.4	FL 616 283	250	224	3.6	barcode read only	
225	7.4	FL 616 284	280	240	4.9	barcode read only	
250	7.4	FL 616 285	315	246	6.7	barcode read only	
315	7.4	FL 616 287	400	285	12.1	barcode read only	
355	7.4	FL 616 288	450	300	16.7	barcode read only	

Maximum continuous operating pressure SDR7.4 - 25 bar water (EN 12201-3)  
4.0mm terminal pins

### COUPLERS – Slideover, SDR 9



Size (mm)	SDR	Product Code	D (mm)	L (mm)	Weight (kg)	Fusion Time (Sec)	Cooling Time (mins)
400	9	FL 616 441	500	320	20.8	barcode read only	
450	9	FL 616 447	560	340	30.0	barcode read only	
500	9	FL 616 445	630	360	40.0	barcode read only	
560	9	FL 616 446	715	380	55.0	barcode read only	
630	9	FL 616 439	810	420	79.6	barcode read only	

Maximum continuous operating pressure SDR9 - 20 bar water (EN 12201-3)  
4.0mm terminal pins

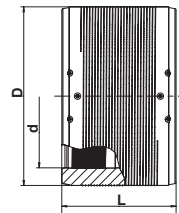

### LONG COUPLERS – Removable Centre Stop



Size (mm)	SDR	Product Code	D (mm)	L (mm)	Weight (kg)	Fusion Time (Sec)	Cooling Time (mins)
32	11	FL 615 736	45	136	0.1	barcode read only	
40	11	FL 615 737	54	146	0.1	barcode read only	
50	11	FL 615 608	68	175	0.3	barcode read only	
63	11	FL 615 738	82	197	0.4	42	7

Maximum continuous operating pressure SDR 11 - 16 bar water (EN 12201-3)  
Manual fusion times are based on 39.5 volt fusion boxes  
4.0mm terminal pins

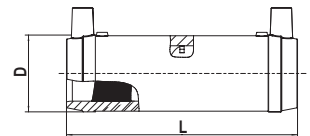

### CONICAL RING COUPLERS



Size (mm)	SDR	Product Code	D (mm)	L (mm)	Weight (kg)	Fusion Time (Sec)	Cooling Time (mins)
1000	17	FL 616 434	1245	1125	350	barcode read only	
1200	17	FL 616 435	1450	1250	500	barcode read only	

Maximum continuous operating pressure SDR 17 - 10 bar water (EN 12201-3)  
4.0mm terminal pins  
Can only be installed using the FRIAMAT XL control unit  
Other sizes maybe available, please contact the sales office.  
Can only be installed with a 10kva 3 phase generator.

## REDUCERS

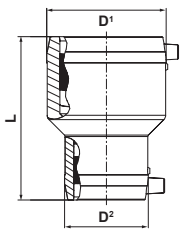

Size (mm)	SDR	Product Code	D <sup>1</sup> (mm)	D <sup>2</sup> (mm)	L (mm)	Weight (kg)	Fusion Time (Sec)	Cooling Time (mins)
32 x 20	11	FL 615 386	45	32	88	0.1	30	5
32 x 25	11	FL 615 502	45	38	88	0.1	30	5
40 x 20	11	FL 615 387	54	32	98	0.1	30	7
40 x 32	11	FL 615 388	54	45	98	0.1	30	7
50 x 20	11	FL 612 069	68	32	110	0.1	30	7
50 x 32	11	FL 612 070	68	45	110	0.1	34	7
50 x 40	11	FL 612 071	68	54	110	0.1	40	7
63 x 32	11	FL 615 389	82	45	125	0.2	32	7
63 x 40	11	FL 615 390	82	54	125	0.2	42	7
63 x 50	11	FL 612 072	82	68	125	0.2	46	7
90 x 50	11	FL 615 391	117	68	160	0.5	55	10
90 x 63	11	FL 615 392	117	82	160	0.5	60	10
110 x 63	11	FL 615 393	142	82	160	0.7	90	10
110 x 90	11	FL 615 693	140	115	180	0.9	180	10
125 x 63	11	69 402 461	159	97	164	1.0	160	18
125 x 90	11	FL 615 694	155	115	200	1.0	240	15
125 x 110	11	FL 616 510	157	138	204	1.3	barcode read only	
160 x 110	11	FL 615 695	201	140	230	2.0	300	20
180 x 125	11	FL 616 511	216	155	274	2.6	300	16
225 x 160	11	FL 616 356	282	203	270	4.9	barcode read only	

Maximum continuous operating pressure SDR 11 - 16 bar water (EN 12201-3)  
 Manual fusion times are based on 39.5 volt fusion boxes  
 4.0mm terminal pins

## REDUCERS



Size (mm)	SDR	Product Code	D <sup>1</sup> (mm)	D <sup>2</sup> (mm)	L (mm)	Weight (kg)	Fusion Time (Sec)	Cooling Time (mins)
250 x 180*	11	FL 402 529				12.2	See individual couplers	
315 x 250*	11	FL 402 543				24.0	See individual couplers	

Maximum continuous operating pressure SDR 11 - 16 bar water (EN 12201-3)  
 4.0mm terminal pins  
 \* Comes in kit form

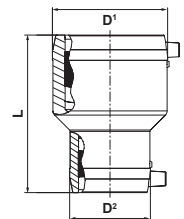

**DID YOU KNOW?**

## LARGE SPIGOT SADDLES

A range of vacuum saddles are available in main sizes from 400mm to 1200mm

Spigot outlet size fabricated to request –  
 Dimensions of finished product change accordingly.

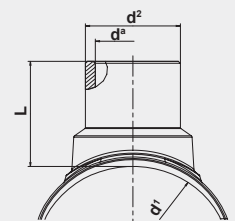

### UNDER CLAMP SPIGOT SADDLES

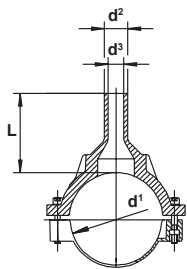

Size (mm)	SDR	Product Code	L (mm)	Drilling (mm)	Weight (kg)	Fusion Time (Sec)	Cooling Time (mins)
63 x 32	11	FL 612 757	100	20	0.3	barcode read only	
63 x 50	11	FL 612 759	113	36	0.4	barcode read only	
75 x 50	11	FL 615 020	82	36	0.4	barcode read only	
90 x 32	11	FL 615 285	103	20	0.7	barcode read only	
90 x 63	11	FL 612 819	103	46	0.7	barcode read only	
110 x 32	11	FL 615 334	125	20	0.8	barcode read only	
110 x 50	11	FL 615 031	132	36	0.8	barcode read only	
110 x 63	11	FL 612 760	150	46	0.9	barcode read only	
110 x 90	11	FL 615 411	115	65	1.0	barcode read only	
125 x 32	11	FL 615 087	109	20	0.9	barcode read only	
125 x 63	11	FL 612 761	109	46	1.0	barcode read only	
125 x 90	11	FL 615 412	116	65	1.1	barcode read only	
125 x 110	11	FL 615 584	116	84	1.2	barcode read only	
160 x 32	11	FL 612 886	126	20	1.4	barcode read only	
160 x 63	11	FL 612 762	140	46	1.5	barcode read only	
160 x 90	11	FL 615 413	140	65	1.6	barcode read only	
160 x 110	11	FL 615 739	140	84	1.8	barcode read only	
160 x 125	11	FL 615 585	140	95	1.9	barcode read only	
180 x 63	11	FL 612 763	109	46	1.2	barcode read only	
180 x 90	11	FL 615 414	116	65	1.8	barcode read only	
180 x 110	11	FL 615 948	136	84	2.0	barcode read only	
180 x 125	11	FL 615 740	141	95	2.1	barcode read only	
200 x 63	11	FL 612 764	109	46	1.3	barcode read only	
225 x 63	11	FL 612 765	109	46	1.2	barcode read only	
225 x 90	11	FL 615 415	130	65	2.0	barcode read only	
225 x 110	11	FL 616 044	140	84	2.0	barcode read only	
225 x 125	11	FL 616 045	146	95	2.2	barcode read only	
225 x 160	11	FL 616 046	157	123	2.6	barcode read only	

Maximum continuous operating pressure SDR 11 - 16 bar water (EN 12201-3)  
4.0mm terminal pins

### TOP LOADING SPIGOT SADDLES



Size (mm)	SDR	Product Code	L (mm)	Weight (kg)	Fusion Time (Sec)	Cooling Time (mins)
250-560(630) x 32	11	FL 615 465	109	0.6	barcode read only	
250-560(630) x 63	11	FL 615 466	109	0.7	550	50

Maximum continuous operating pressure SDR 11 - 16 bar water (EN 12201-3)  
Manual fusion times are based on 39.5 volt fusion boxes  
4.0mm terminal pins

*Note:* These fittings require special instructions when used at 630mm - please contact our Technical Support Department.

Friatop clamping unit shall be used to install this range of fittings.

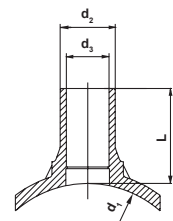

## EQUAL TEES



Size (mm)	SDR	Product Code	D (mm)	L (mm)	L <sup>1</sup> (mm)	Weight (kg)	Fusion Time (main) (Sec)	Fusion Time (branch) (Sec)	Cooling Time (mins)
25	11	FL 616 338	36	108	110	0.2	30	-	5
32	11	FL 615 719	44	116	131	0.2	28	-	5
40	11	FL 615 720	53	146	151	0.3	barcode read only		
50	11	FL 615 721	67	175	186	0.5	34	-	7
63	11	FL 615 722	81	197	203	0.8	42	-	7



Size (mm)	SDR	Product Code	D (mm)	L (mm)	L <sup>1</sup> (mm)	Weight (kg)	Fusion Time (main) (Sec)	Fusion Time (branch) (Sec)	Cooling Time (mins)
75	11	FL 612 165	96	278	187	1.0	72	80	10
90	11	FL 612 166	117	305	211	1.7	90	90	10
110	11	FL 612 167	142	355	248	2.6	140	160	10
125	11	FL 612 168	160	384	272	3.5	180	200	15
160	11	FL 615 277	200	430	315	5.8	400	400	20
180	11	FL 615 691	228	480	354	7.9	440	440	20
200	11	FL 616 266	251	550	400	11.1	465	465	20
225	11	FL 615 692	280	580	430	13.9	540	540	20

Maximum continuous operating pressure SDR 11 - 16 bar water (EN 12201-3)  
 Manual fusion times are based on 39.5 volt fusion boxes  
 4.0mm terminal pins

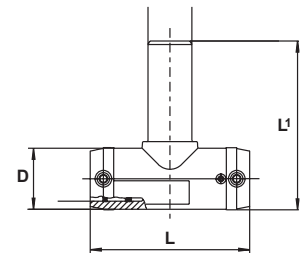

## LARGE DIAMETER EQUAL TEES



Size (mm)	SDR	Product Code	D (mm)	L (mm)	L <sup>1</sup> (mm)	Weight (kg)	Fusion Time (main) (Sec)	Fusion Time (branch) (Sec)	Cooling Time (mins)
250	11	FL 616 412	310	770	540	27.4	550	-	30
280	11	FL 616 413	350	905	630	42.2	550	-	30
315	11	FL 616 414	396	940	670	55.9	550	-	30

Maximum continuous operating pressure SDR 11 - 16 bar water (EN 12201-3)  
 Manual fusion times are based on 39.5 volt fusion boxes  
 4.0mm terminal pins

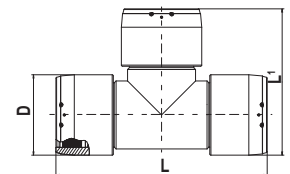



### REDUCED BRANCH TEES



Size (mm)	SDR	Product Code	D (mm)	L (mm)	L <sup>1</sup> (mm)	Weight (kg)	Fusion Time (main) (Sec)	Cooling Time (mins)
32 x 20	11	FL 616 417	46	116	117	0.1	28	5
40 x 32	11	FL 616 418	55	146	148	0.2	barcode read only	
50 x 32	11	FL 616 419	69	175	158	0.3	34	7
50 x 40	11	FL 616 420	69	175	167	0.3	34	7
63 x 32	11	FL 616 421	84	197	173	0.4	46	7
63 x 40	11	FL 616 422	84	197	182	0.5	46	7
63 x 50	11	FL 616 423	84	197	197	0.5	46	7

Maximum continuous operating pressure SDR 11 - 16 bar water (EN 12201-3)  
 Manual fusion times are based on 39.5 volt fusion boxes  
 4.0mm terminal pins

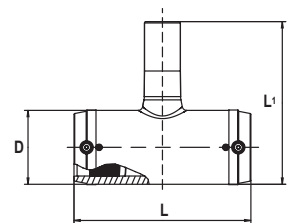

**DID YOU KNOW?**

### LARGE REDUCED BRANCH TEES

A range of large reduced branch tees are available in main sizes 250mm, 280mm and 315m.

Main lengths combined with electrofusion couplers.  
 Spigot outlet size fabricated to request –  
 Dimensions of finished product change accordingly.

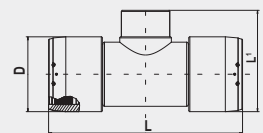

### 90° ELBOWS



Size (mm)	SDR	Product Code	D (mm)	L (mm)	Weight (kg)	Fusion Time (Sec)	Cooling Time (mins)
25	11	FL 612 091	37	73	0.1	32	5
32	11	FL 612 093	43	82	0.1	24	5
40	11	FL 612 095	53	96	0.1	30	7
50	11	FL 612 097	66	113	0.2	34	7
63	11	FL 612 099	83	136	0.3	44	7
75	11	FL 612 101	96	170	0.6	70	10
90	11	FL 612 103	115	202	1.0	90	10
110	11	FL 612 105	138	234	1.6	140	10
125	11	FL 612 107	157	254	2.0	180	15
160	11	FL 615 276	207	329	4.9	360	20
180	11	FL 615 689	228	354	5.8	440	20
200	11	FL 616 265	254	392	8.6	450	20
225	11	FL 615 690	280	430	10.2	barcode read only	

Maximum continuous operating pressure SDR 11 - 16 bar water (EN 12201-3)  
 Manual fusion times are based on 39.5 volt fusion boxes  
 4.0mm terminal pins

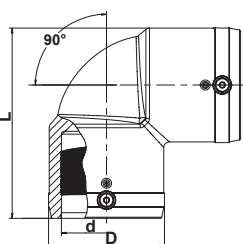

## LARGE DIAMETER 90° ELBOWS



Size (mm)	SDR	Product Code	D (mm)	L (mm)	Weight (kg)	Fusion Time (Sec)	Cooling Time (mins)
250	11	FL 616 408	310	534	19.1	550	30
280	11	FL 616 409	350	621	27.5	550	30
315	11	FL 616 410	396	677	40.0	550	30

Maximum continuous operating pressure SDR 11 - 16 bar water (EN 12201-3)  
Manual fusion times are based on 39.5 volt fusion boxes  
4.0mm terminal pins

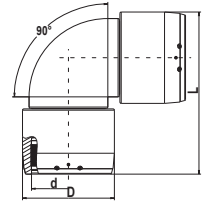

## 45° ELBOWS



Size (mm)	SDR	Product Code	D (mm)	L (mm)	Weight (kg)	Fusion Time (Sec)	Cooling Time (mins)
32	11	FL 612 092	43	102	0.1	24	5
40	11	FL 612 094	54	120	0.1	30	7
50	11	FL 612 096	66	136	0.2	34	7
63	11	FL 612 098	82	158	0.3	44	7
75	11	FL 612 100	96	198	0.5	70	10
90	11	FL 612 102	115	232	0.8	90	10
110	11	FL 612 104	138	265	1.3	140	10
125	11	FL 612 106	157	279	1.8	180	15
160	11	FL 615 275	207	377	4.4	360	20
180	11	FL 615 687	228	382	4.6	440	20
200	11	FL 616 264	254	415	6.8	450	20
225	11	FL 615 688	280	450	8.3	635	20

Maximum continuous operating pressure SDR 11 - 16 bar water (EN 12201-3)  
Manual fusion times are based on 39.5 volt fusion boxes  
4.0mm terminal pins

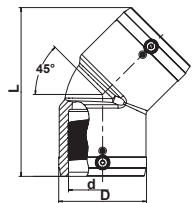

## LARGE DIAMETER 45° ELBOWS



Size (mm)	SDR	Product Code	D (mm)	L (mm)	Weight (kg)	Fusion Time (Sec)	Cooling Time (mins)
250	11	FL 616 404	310	621	17.3	550	30
280	11	FL 616 405	350	702	25.6	550	30
315	11	FL 616 406	396	755	36.0	550	30

Maximum continuous operating pressure SDR 11 - 16 bar water (EN 12201-3)  
Manual fusion times are based on 39.5 volt fusion boxes  
4.0mm terminal pins

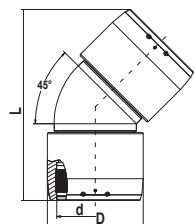

### 30° ELBOWS



Size (mm)	SDR	Product Code	D (mm)	L (mm)	Weight (kg)	Fusion Time (Sec)	Cooling Time (mins)
90	11	FL 615 272	115	224	0.8	90	10
110	11	FL 615 273	142	252	1.3	140	10
125	11	FL 615 274	158	270	1.6	180	15
160	11	FL 615 340	199	350	3.9	360	20
180	11	FL 616 261	229	390	5.0	440	20
200	11	FL 616 262	254	412	6.4	450	20
225	11	FL 616 263	281	456	8.2	620	20

Maximum continuous operating pressure SDR 11 - 16 bar water (EN 12201-3)  
 Manual fusion times are based on 39.5 volt fusion boxes  
 4.0mm terminal pins

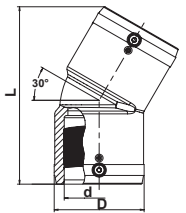

### END CAPS



Size (mm)	SDR	Product Code	D (mm)	L (mm)	Weight (kg)	Fusion Time (Sec)	Cooling Time (mins)
20	11	FL 612 025	31	62	0.1	24	5
25	11	FL 612 026	35	65	0.1	28	5
32	11	FL 612 027	44	70	0.1	26	5
40	11	FL 612 028	55	75	0.1	34	7
50	11	FL 612 029	67	80	0.1	56	7
63	11	FL 612 030	84	88	0.2	52	7
75	11	FL 612 031	99	99	0.3	86	10
90	11	FL 612 032	117	155	0.5	90	10
110	11	FL 612 033	143	125	0.8	170	10
125	11	FL 612 034	158	186	1.2	235	15
160	11	FL 612 035	206	262	2.2	460	20
180	11	FL 616 183	225	195	2.8	440	20
200	11	FL 616 184	250	210	3.9	527	20
225	11	FL 616 185	280	230	5.1	550	20

Maximum continuous operating pressure SDR 11 - 16 bar water (EN 12201-3)  
 Manual fusion times are based on 39.5 volt fusion boxes  
 4.0mm terminal pins

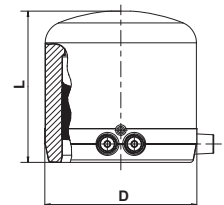

## TRANSITION COUPLERS PE100/ BRASS MALE THREAD



Size (mm x inch)	SDR	Product Code	D (mm)	L (mm)	Weight (kg)	Fusion Time (Sec)	Cooling Time (mins)
32 x 1	11	FL 612 712	47	112	0.3	barcode read only	
32 x 1¼	11	FL 612 709	47	120	0.4	barcode read only	
32 x 1½	11	FL 612 698	47	121	0.5	barcode read only	
40 x 1	11	FL 612 721	58	123	0.5	barcode read only	
40 x 1¼	11	FL 612 713	58	126	0.5	barcode read only	
40 x 1½	11	FL 612 718	58	127	0.5	barcode read only	
40 x 2	11	FL 612 725	58	132	0.7	barcode read only	
50 x 1	11	FL 612 719	70	134	0.6	barcode read only	
50 x 1¼	11	FL 612 716	70	136	0.6	barcode read only	
50 x 1½	11	FL 612 714	70	137	0.6	44	7
50 x 2	11	FL 612 706	70	147	0.8	barcode read only	
63 x 1¼	11	FL 612 722	84	138	0.9	barcode read only	
63 x 1½	11	FL 612 717	84	137	0.9	48	7
63 x 2	11	FL 612 715	84	142	0.9	48	7

Maximum continuous operating pressure SDR 11 - 16 bar water (EN 12201-3)  
Manual fusion times are based on 39.5 volt fusion boxes  
4.0mm terminal pins

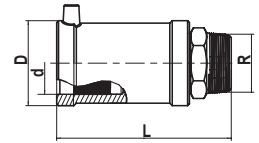

## TRANSITION COUPLERS PE100/ GUNMETAL FEMALE THREAD



Size (mm x inch)	SDR	Product Code	D (mm)	L (mm)	Weight (kg)	Fusion Time (Sec)	Cooling Time (mins)
32 x 1	11	FL 612 595	47	112	0.4	barcode read only	
40 x 1¼	11	FL 612 596	58	121	0.5	barcode read only	
50 x 1½	11	FL 612 692	70	136	0.7	44	7
63 x 1½	11	FL 612 708	84	141	1.2	48	7
63 x 2	11	FL 612 693	84	141	1.1	48	7

Maximum continuous operating pressure SDR 11 - 16 bar water (EN 12201-3)  
Manual fusion times are based on 39.5 volt fusion boxes  
4.0mm terminal pins

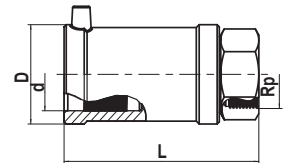

**90° TRANSITION  
ELBOWS PE100/  
BRASS MALE THREAD**



Size (mm x inch)	SDR	Product Code	D (mm)	L (mm)	Weight (kg)	Fusion Time (Sec)	Cooling Time (mins)
32 x 1	11	FL 612 120	47	85	0.3	barcode read only	
32 x 1½	11	FL 612 140	47	94	0.5	barcode read only	
40 x 1	11	FL 612 127	58	102	0.5	barcode read only	
40 x 1¼	11	FL 612 122	58	102	0.5	barcode read only	
40 x 1½	11	FL 612 121	58	102	0.6	barcode read only	
50 x 1	11	FL 612 119	70	118	0.7	barcode read only	
50 x 1¼	11	FL 612 123	70	118	0.7	barcode read only	
50 x 1½	11	FL 612 124	70	118	0.7	44	7
63 x 1½	11	FL 612 125	84	128	1.0	48	7
63 x 2	11	FL 612 126	84	128	1.0	48	7

Maximum continuous operating pressure SDR 11 - 16 bar water (EN 12201-3)  
Manual fusion times are based on 39.5 volt fusion boxes  
4.0mm terminal pins

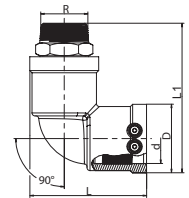

**REINFORCING  
SADDLES**



Size (mm)	SDR	Product Code	H (mm)	Weight (kg)	Fusion Time (Sec)	Cooling Time (mins)
63	11	FL 612 519	106	0.3	barcode read only	

Maximum continuous operating pressure SDR 11 - 16 bar water (EN 12201-3)  
4.0mm terminal pins

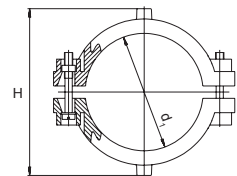

**REPAIR &  
REINFORCING  
SADDLES**



Size (mm)	SDR	Product Code	H (mm)	Weight (kg)	Fusion Time (Sec)	Cooling Time (mins)
90	11	FL 615 164	148	1.0	barcode read only	
110	11	FL 615 165	168	1.2	barcode read only	
125	11	FL 615 166	183	1.4	barcode read only	
160	11	FL 615 168	218	1.7	barcode read only	
180	11	FL 615 169	238	1.9	barcode read only	
200	11	FL 615 170	258	1.9	barcode read only	
225	11	FL 615 171	283	1.9	barcode read only	

Maximum continuous operating pressure SDR 11 - 16 bar water (EN 12201-3)  
4.0mm terminal pins

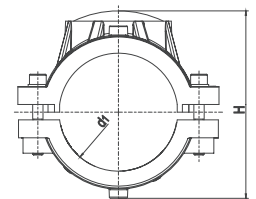

## REPAIR SADDLES



Size (mm)	SDR	Product Code	Repair diameter, dR (mm)	Weight (kg)	Fusion Time (Sec)	Cooling Time (mins)
560	17	FL 616 367	230	14.3	barcode read only	
630	17	FL 616 368	230	15.0	barcode read only	
710	17	FL 616 369	230	18.9	barcode read only	
800	17	FL 616 370	230	15.8	barcode read only	
900	17	FL 616 371	230	17.6	barcode read only	
1000	17	FL 616 372	230	16.4	barcode read only	
1200	17	FL 616 379	230	16.3	barcode read only	

Maximum continuous operating pressure SDR 17 - 10 bar water (EN 12201-3)  
 4.0mm terminal pins  
 Only for use with the Friatec VACUSET XL Clamping Equipment - please contact our Technical Support Department for further information.

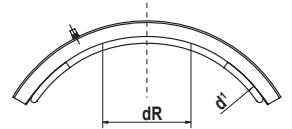

## TOP LOADING REPAIR SADDLE



Size (mm)	SDR	Product Code	d <sup>3</sup> (mm)	Weight (kg)	Fusion Time (Sec)	Cooling Time (mins)
250-560	11	FL 615 397	50	0.6	barcode read only	

Maximum continuous operating pressure SDR 11 - 16 bar water (EN 12201-3)  
 4.0mm terminal pins

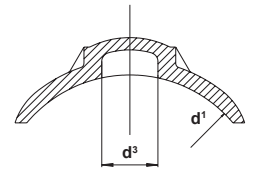

## 32MM TOP LOADING TAPPING TEES



Size (mm)	SDR	Product Code	A (mm)	B (mm)	Z <sup>1</sup> (mm)	Z <sup>2</sup> (mm)	Weight (kg)	Fusion Time (Sec)	Cooling Time (mins)
63/2" x 32	11	FL 411 415	98	109	79	58	0.3	70	4
75 x 32	11	FL 411 416	98	109	79	66	0.3	70	4
90/3" x 32	11	FL 411 417	98	109	79	71	0.3	70	4
110-140/4" x 32	11	FL 411 419	98	109	79	81-96	0.3	70	4
160-213/6" x 32	11	FL 411 422	98	109	79	106-133	0.3	70	4
225-315 x 32	11	FL 411 427	138	109	79	141-186	0.3	70	4

Maximum continuous operating pressure SDR 11 - 12.5 bar water (EN 12201-3)  
 Manual fusion times are based on 39.5 volt fusion boxes  
 4.0mm terminal pins  
 Product supplied may vary in design to that shown above. Supplied complete with 12mm hexagon drive cutter.

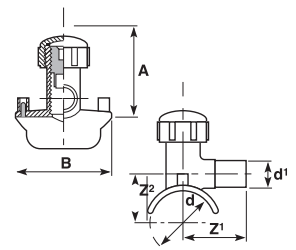

**UNDER CLAMPED  
PRESSURE  
TAPPING TEES**



**NEW PRODUCT  
DESIGN AVAILABLE\***

Size (mm)	SDR	Product Code	L (mm)	D <sup>3</sup> (mm)	Weight (kg)	Fusion Time (Sec)	Cooling Time (mins)
90 x 63	11	<b>FL 612 701</b>	125	50	1.3	120	20
110 x 63	11	<b>FL 612 624</b>	121	50	1.3	barcode read only	
125 x 63	11	<b>FL 612 309</b>	122	50	1.3	barcode read only	
160 x 63	11	<b>FL 612 650</b>	165	50	1.3	barcode read only	
180 x 63	11	<b>FL 612 652</b>	165	50	1.3	barcode read only	
200 x 63	11	<b>FL 612 659</b>	165	50	1.3	barcode read only	
225 x 63	11	<b>FL 612 655</b>	165	50	1.3	barcode read only	

Maximum continuous operating pressure SDR 11 - 16 bar water (EN 12201-3)  
 Manual fusion times are based on 39.5 volt fusion boxes  
 4.0mm terminal pins  
 90mm x 63mm (FL 610 701), 125mm x 63mm (FL 610 309) and 180mm x 63mm (FL 610 652) are also available as kits with a Cap for Pressure Tapping Tees. Contact Sales Office for further information.  
 Utilize a 19mm hexagonal drive cutter. If actuator key required, order item FE 613 250  
 \* Utilize a 17mm hexagonal drive cutter. If actuator key required, order item FE 613 246

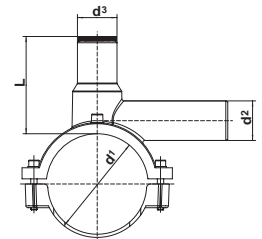

**TOP LOADING  
PRESSURE  
TAPPING TEE**



Size (mm)	SDR	Product Code	L (mm)	D <sup>3</sup> (mm)	Weight (kg)	Fusion Time (Sec)	Cooling Time (mins)
250-315(355-400) x 63	11	<b>FL 615 339</b>	167	50	1.5	barcode read only	

Maximum continuous operating pressure SDR 11 - 12.5 bar water (EN 12201-3)  
 - for mains sizes up to 315mm  
 Maximum continuous operating pressure SDR 17 - 10 bar water (EN 12201-3)  
 - for mains 355mm and 400mm  
 Manual fusion times are based on 39.5 volt fusion boxes  
 4.0mm terminal pins  
 Friatop Clamping Unit should be used to install this fitting

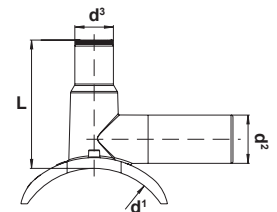

**CAP FOR  
PRESSURE  
TAPPING TEES**



Size (mm)	SDR	Product Code	D (mm)	L (mm)	Weight (kg)	Fusion Time (Sec)	Cooling Time (mins)
50	11	<b>FL 612 310</b>	69	72	0.1	barcode read only	

4.0mm terminal pins

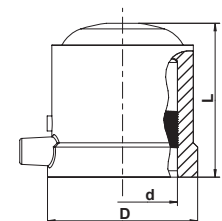

## FLANGED BRANCH TEES

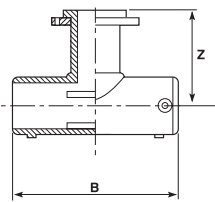

Size (mm)	SDR	Product Code	B (mm)	Z (mm)	Weight (kg)	Fusion Time (Sec)	Cooling Time (mins)
90 x 80 PN16	11	FL 301 313	305	236	3.5	90	10
110 x 80 PN16	11	FL 301 314	355	459	4.9	160	10
125 x 80 PN16	11	FL 301 315	384	503	6.0	200	15
160 x 80 PN16	11	FL 301 317	430	560	8.7	400	20
180 x 80 PN16	11	FL 301 318	480	812	12.2	440	20
90 x 100 PN16	11	FL 302 313	305	438	4.3	90	10
110 x 100 PN16	11	FL 302 314	355	353	4.7	160	10
125 x 100 PN16	11	FL 302 315	384	301	6.0	200	15
160 x 100 PN16	11	FL 302 317	430	528	9.0	400	20
180 x 100 PN16	11	FL 302 318	480	600	12.2	440	20
160 x 150 PN16	11	FL 303 317	430	365	9.7	400	20
180 x 150 PN16	11	FL 303 318	480	365	12.7	440	20

Manual fusion times are based on 39.5 volt fusion boxes  
4.0mm terminal pins

Dimension Z is an approximate value, based on the dimensions of the component parts. The nature of the fabrication process is such that the final dimension may be slightly less than the Z value quoted.

Drilled to BS EN 1092-1:2007 Table 13.

## FULL FACED FLANGED BRANCH TEES



Size (mm)	SDR	Product Code	D (mm)	d <sup>k</sup> (mm)	H (mm)	L (mm)	Ø k (mm)	Weight (kg)	Fusion Time (Sec)	Cooling Time (mins)
110 x 80 PN16	11	FL 615 590	204	16.5	316	355	160	4.9	barcode read only	
125 x 80 PN16	11	FL 615 591	204	16.5	343	384	160	5.5	barcode read only	
160 x 80 PN16	11	FL 615 592	204	16.5	390	430	160	8.1	barcode read only	
180 x 80 PN16	11	FL 615 910	204	16.5	416	480	160	10.0	barcode read only	
Maximum continuous operating pressure SDR 11 - 16 bar water (EN 12201-3)										
225 x 80 PN16	17	FL 616 031	204	16.5	465	580	160	15.4	barcode read only	

Maximum continuous operating pressure SDR 17 - 10 bar water (EN 12201-3)

Drilled to BS EN 1092-1:2007 Table 13.

Additional washers are necessary for the flange

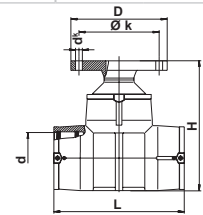

## FULL FACED FLANGED BRANCH SADDLES



Size (mm)	SDR	Product Code	D (mm)	d <sup>k</sup> (mm)	Drilling Ø da (mm)	Ø k (mm)	Z (mm)	Weight (kg)	Fusion Time (Sec)	Cooling Time (mins)
110 x 80 PN16	11	FL 616 016	204	16.5	65	160	180	3.7	barcode read only	
125 x 80 PN16	11	FL 616 017	204	16.5	65	160	180	3.9	barcode read only	
160 x 80 PN16	11	FL 616 018	204	16.5	65	160	180	4.3	barcode read only	
180 x 80 PN16	11	FL 616 019	204	16.5	65	160	180	4.6	barcode read only	
225 x 80 PN16	11	FL 616 020	204	16.5	65	160	180	4.7	barcode read only	
160 x 100 PN16	11	FL 616 022	224	16.5	84	180	180	5.3	barcode read only	
225 x 100 PN16	11	FL 616 024	224	16.5	84	180	180	5.6	barcode read only	

Maximum continuous operating pressure SDR 11 - 16 bar water (EN 12201-3)

Manual fusion times are based on 39.5 volt fusion boxes

Drilled to BS EN 1092-1:2007 Table 13.

Additional washers are required for the flange

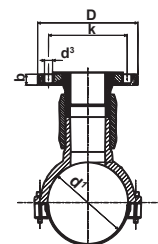



### DUCK FOOT BENDS



Example of 180 x 80 PN16

Size (mm)	SDR	Product Code	A (mm)	B (mm)	C x C <sup>1</sup> (mm)	D x D <sup>1</sup> (mm)	SDR 11 Weight (kg)
63 x 80 PN16	11	FL 384 459	230	270	200 x 230	160 x 180	4.1
90 x 80 PN16	11	FL 384 313	200	270	200 x 230	160 x 180	4.0
125 x 80 PN16	11	FL 384 484	250	270	200 x 230	160 x 180	4.7
180 x 80 PN16	11	FL 384 487	490	270	200 x 230	160 x 180	8.1

Other sizes made to order upon request subject to minimum order values/quantities.  
Available in kit form only

#### KIT COMPRISES

- 1 x base
- 1 x electrofusion tee
- 1 x pupped full faced stub flange assembly (0.5m pep approximately),
- 1 x reducer/expander to suit input size. Bolts NOT included

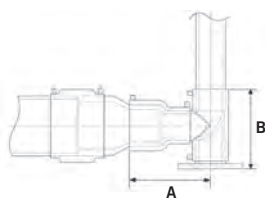

Example of 63 x 80 PN16

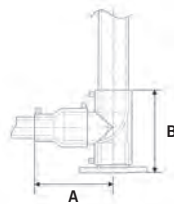

Base dimensions

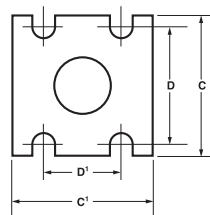

### FLANGE ADAPTOR KITS



Size (mm)	SDR	Product Code
63 x 50	11	FL 251 311
90 x 80	17	FL 250 313
125 x 100	17	FL 250 315
90 x 100	17	FL 250 484
160 x 150	17	FL 250 317
180 x 150	17	FL 250 318
250 x 250	17	FL 250 321
250 x 200	17	FL 250 534
315 x 300	17	FL 250 323

Drilled to BS EN 1092-1:2007 Table 13.

Note: Sizes 250 and 315mm have sections of pipe butt-fused to the moulding.

#### ADAPTOR KIT COMPRISES

- 1 x Stub Flange
- 1 X Coupler
- 1 x Gasket (representation)
- 1 x Backing Ring

### ELECTROFUSION WIPES



Product Code
53 996 603

Complies with WIS 4-32-08  
Safety data sheet available upon request.

# SPIGOT FITTINGS

SPIGOT FITTINGS FOR POTABLE & NON-POTABLE WATER



## FEATURES & BENEFITS

- Ease of installation
- Increase in installation productivity
- Beneficial where operational footprint is tight
- Can be pre-fabricated off site
- Available in SDR 11 and SDR 17 in sizes up to 630mm

### Available in a wide range of shapes

- Reducers
- Elbows
- Equal Tees
- Stub Flanges
- Stub Flange Adaptor Kits
- Reduced Branch Tees
- Flanged Branch Tees
- All Flanged Equal Tees
- End Caps
- 90°, 45°, 22½° and 11¼° Formed Bends
- Stub Flange Assembly

## DID YOU KNOW?

**Prefabricated Papped spigots can reduce installation time by up to 40% when compared to fabricating on site**

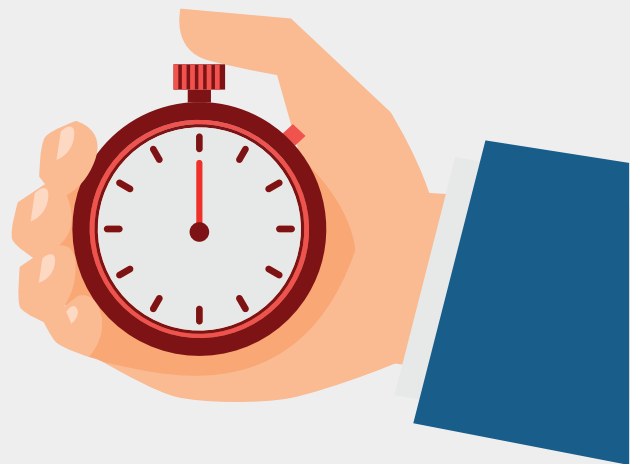

# SPIGOT FITTINGS FOR ELECTROFUSION JOINTING OR BUTT FUSION WITH NARROW CLAMPS

## REDUCERS

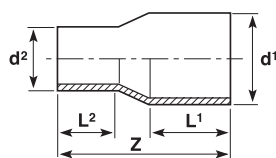

Size (mm)	SDR 11 Code	SDR 17 Code	L <sup>1</sup> (mm)	L <sup>2</sup> (mm)	Z (mm)	SDR 11 Weight (kg)	SDR 17 Weight (kg)
32 x 25	40 441 409	-	61	59	130	0.1	-
40 x 25	40 441 410	-	59	54	128	0.1	-
40 x 32	40 441 413	-	49	44	105	0.1	-
50 x 25	40 441 411	-	56	42	132	0.1	-
50 x 32	40 441 414	-	57	47	132	0.1	-
50 x 40	40 441 429	-	55	51	134	0.1	-
63 x 25	40 441 395	-	64	63	143	0.1	-
63 x 32	40 441 415	-	63	44	146	0.1	-
63 x 40	40 441 430	-	63	49	147	0.1	-
63 x 50	40 441 444	-	64	58	152	0.1	-
75 x 32	40 441 416	-	70	55	155	0.2	-
75 x 40	40 441 431	-	70	55	155	0.2	-
75 x 50	40 441 445	-	70	55	155	0.2	-
75 x 63	40 441 458	40 440 445	70	65	171	0.2	0.2
90 x 50	40 441 446	40 440 446	79	57	174	0.3	0.2
90 x 63	40 441 459	40 440 459	79	70	182	0.3	0.2
90 x 75	40 441 471	40 440 471	79	70	180	0.3	0.2
110 x 50	40 441 447	40 440 447	84	69	185	0.4	0.3
110 x 63	40 441 460	40 440 460	84	69	185	0.4	0.3
110 x 75	40 441 472	40 440 472	84	74	185	0.5	0.3
110 x 90	40 441 483	40 440 483	84	81	186	0.5	0.3
125 x 63	40 441 461	40 440 461	91	69	200	0.6	0.5
125 x 75	40 441 473	40 440 473	95	78	191	0.6	0.4
125 x 90	40 441 484	40 440 484	91	80	202	0.7	0.5
125 x 110	40 441 493	40 440 493	96	84	192	0.7	0.5
140 x 90	40 441 485	40 440 485	116	90	230	1.0	0.7
140 x 110	40 441 494	40 440 494	116	90	230	1.0	0.7
140 x 125	40 441 503	40 440 503	117	96	235	1.1	0.7
160 x 90	40 441 486	40 440 486	101	82	221	1.1	0.7
160 x 110	40 441 495	40 440 495	110	89	254	1.3	0.9
160 x 125	40 441 504	40 440 504	110	95	254	1.4	1.0
160 x 140	40 441 512	40 440 512	110	106	241	1.6	1.0
180 x 125	40 441 505	40 440 505	105	87	245	1.7	1.1
180 x 140	40 441 513	40 440 513	115	100	258	1.9	1.3
180 x 160	40 441 520	40 440 520	126	125	279	2.1	1.5
200 x 140	40 441 514	40 440 514	123	114	279	2.3	1.6
200 x 160	40 441 521	40 440 521	122	122	277	2.4	1.7
200 x 180	40 441 527	40 440 527	126	120	279	2.7	1.8
225 x 160	40 441 522	40 440 522	132	123	295	3.1	2.2
225 x 180	40 441 528	40 440 528	130	118	285	3.2	2.1
225 x 200	40 441 533	40 440 533	126	120	272	3.4	2.2
250 x 180	40 441 529	40 440 529	151	105	316	4.3	2.9
250 x 200	40 441 534	40 440 534	151	116	324	4.7	3.2
250 x 225	40 441 538	40 440 538	155	122	330	5.3	3.6
280 x 200	40 441 535	40 440 535	140	116	345	5.9	3.9
280 x 225	40 441 539	40 440 539	140	120	345	6.2	4.1
280 x 250	40 441 542	40 440 542	139	135	340	6.7	4.4
315 x 225	40 441 540	40 440 540	150	125	365	8.0	5.3
315 x 250	40 441 543	40 440 543	150	134	365	8.1	5.6
355 x 250	40 441 544	40 440 544	164	130	330	8.7	5.9
355 x 280	40 441 546	40 440 546	164	150	341	9.3	6.3
355 x 315	40 441 547	40 440 547	164	160	341	9.9	6.8

Maximum continuous operating pressure SDR 11 - 16 bar water (EN 12201-3)

Maximum continuous operating pressure SDR 17 - 10 bar water (EN 12201-3)

## 90° ELBOWS

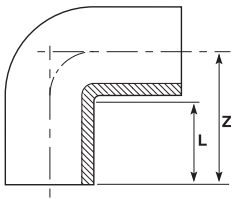

Size (mm)	SDR 11 Code	SDR 17 Code	L (mm)	Z (mm)	SDR 11 Weight (kg)	SDR 17 Weight (kg)
32	40 209 308	-	70	95	0.1	-
50	40 209 310	-	80	108	0.2	-
63	40 209 311	-	80	117	0.3	-
75	40 210 312	40 208 312	90	132	0.4	0.3
90	40 210 313	40 208 313	91	142	0.6	0.5
110	40 210 314	40 208 314	99	162	1.1	0.8
125	40 210 315	40 208 315	103	169	1.5	1.0
140	40 210 316	40 208 316	120	200	2.3	1.6
160	40 210 317	40 208 317	142	233	3.4	2.4
180	40 210 318	40 208 318	142	247	4.4	3.0
200	40 210 319	40 208 319	153	262	6.1	4.2
225	40 210 320	40 208 320	154	281	8.0	5.6
250	40 210 321	40 208 321	134	293	11.0	7.8
280	40 210 322	40 208 322	144	330	15.0	10.7
315	40 210 323	40 208 323	154	370	21.4	15.8

Maximum continuous operating pressure SDR 11 - 16 bar water (EN 12201-3)

Maximum continuous operating pressure SDR 17 - 10 bar water (EN 12201-3)

*Note:* 250 and 315mm sizes have sections of pipe butt-fused to the moulding.  
On these sizes L = minimum length of pipe added.

## 45° ELBOWS

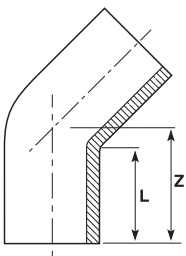

Size (mm)	SDR 11 Code	SDR 17 Code	L (mm)	Z (mm)	SDR 11 Weight (kg)	SDR 17 Weight (kg)
32	40 215 308	-	71	90	0.1	-
50	40 215 310	-	62	76	0.1	-
63	40 215 311	-	66	88	0.2	-
75	40 216 312	40 214 312	71	90	0.3	0.2
90	40 216 313	40 214 313	83	105	0.5	0.3
110	40 216 314	40 214 314	93	121	0.9	0.6
125	40 216 315	40 214 315	99	137	1.2	0.8
140	40 216 316	40 214 316	121	168	1.8	1.3
160	40 216 317	40 214 317	142	190	2.7	1.9
180	40 216 318	40 214 318	141	196	3.5	2.5
200	40 216 319	40 214 319	153	207	4.8	3.3
225	40 216 320	40 214 320	154	210	6.1	4.3
250	40 216 321	40 214 321	133	220	8.3	5.9
280	40 216 322	40 214 322	144	227	10.6	7.7
315	40 216 323	40 214 323	155	250	14.7	10.4

Maximum continuous operating pressure SDR 11 - 16 bar water (EN 12201-3)

Maximum continuous operating pressure SDR 17 - 10 bar water (EN 12201-3)

*Note:* 250 and 315mm sizes have sections of pipe butt-fused to the moulding.  
On these sizes L = minimum length of pipe added.

## 90° EQUAL TEES

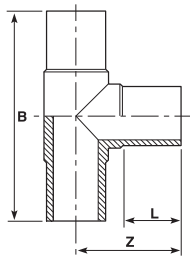

Size (mm)	SDR 11 Code	SDR 17 Code	L (mm)	B (mm)	Z (mm)	SDR 11 Weight (kg)	SDR 17 Weight (kg)
63	40 221 311	-	65	216	105	0.3	-
75	40 222 312	40 220 312	72	248	122	0.5	0.4
90	40 222 313	40 220 313	80	277	137	0.9	0.7
110	40 222 314	40 220 314	88	321	162	1.6	1.1
125	40 222 315	40 220 315	98	350	176	2.2	1.6
140	40 222 316	40 220 316	104	399	200	3.2	2.2
160	40 222 317	40 220 317	104	413	206	4.3	3.0
180	40 222 318	40 220 318	143	528	260	6.9	4.9
200	40 222 319	40 220 319	124	505	253	8.3	5.7
225	40 222 320	40 220 320	129	559	278	11.7	8.3
250	40 222 321	40 220 321	132	582	291	14.0	9.4
280	40 222 322	40 220 322	133	622	312	18.9	13.0
315	40 222 323	40 220 323	153	690	351	26.4	17.7

Maximum continuous operating pressure SDR 11 - 16 bar water (EN 12201-3)

Maximum continuous operating pressure SDR 17 - 10 bar water (EN 12201-3)

Note: 250 and 315mm sizes have sections of pipe butt-fused to the moulding.  
On these sizes L = minimum length of pipe added.

## STUB FLANGES

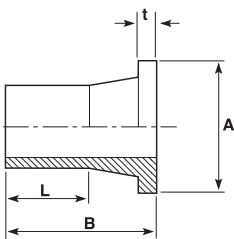

Size (mm)	SDR 11 Code	SDR 17 Code	A (mm)	B (mm)	L (mm)	t (mm)	SDR 11 Weight (kg)	SDR 17 Weight (kg)
32	40 227 308	-	68	86	62	10	0.1	-
40	40 227 309	-	78	89	62	11	0.1	-
50	40 227 310	-	88	90	62	12	0.1	-
63	40 227 311	-	102	106	70	14	0.2	-
75	40 228 312	40 226 312	122	129	94	16	0.3	0.3
90	40 228 313	40 226 313	138	140	100	17	0.5	0.4
110	40 228 314	40 226 314	158	160	113	18	0.7	0.6
125	40 228 315	40 226 315	158	183	134	25	1.0	0.7
140	40 228 316	40 226 316	188	182	128	25	1.3	0.9
160	40 228 317	40 226 317	212	208	155	25	1.8	1.3
180	40 228 318	40 226 318	212	202	168	30	2.0	1.3
200	40 228 319	40 226 319	268	200	128	32	3.1	2.2
225	40 228 320	40 226 320	268	201	135	32	3.3	2.3
250	40 228 321	40 226 321	320	219	138	35	5.2	3.7
280	40 228 322	40 226 322	320	231	152	35	5.6	3.8
315	40 228 323	40 226 323	370	239	158	35	7.6	5.3
355	40 228 324	40 226 324	430	260	176	40	10.7	7.4

Maximum continuous operating pressure SDR 11 - 16 bar water (EN 12201-3)

Maximum continuous operating pressure SDR 17 - 10 bar water (EN 12201-3)

Note: 250 to 355mm sizes have sections of pipe butt-fused to the moulding.  
On these sizes L = minimum length of pipe added.

## STUB FLANGE ASSEMBLIES



Size (mm)	SDR 11 Code	SDR 17 Code	SDR 11 Weight (kg)	SDR 17 Weight (kg)
63 x 50	40 329 311	-	1.3	-
90 x 80	40 329 313	40 328 313	1.8	1.7
110 x 100	40 329 314	40 328 314	2.1	2.0
125 x 100	40 329 315	40 328 315	2.5	2.2
160 x 150	40 329 317	40 328 317	3.9	3.4
180 x 150	40 329 318	40 328 318	4.8	4.1
225 x 200	40 329 320	40 328 320	6.8	5.8
250 x 250	40 329 321	40 328 321	12.1	10.6
315 x 300	40 329 323	40 328 323	14.5	14.2

Maximum continuous operating pressure SDR 11 - 16 bar water (EN 12201-3)  
 Maximum continuous operating pressure SDR 17 - 10 bar water (EN 12201-3)  
 Stub Flange Assemblies include the appropriate backing ring and gasket. Bolt set not supplied.  
 Drilled to BS EN 1092-1:2007 Table 13.

## FULL FACED FLANGES



Size (mm)	SDR	Product Code	D (mm)	d <sub>i</sub> (mm)	d <sub>k</sub> (mm)	L (mm)	Weight (kg)
63 x 50 PN10/16	11	FL 615 417	169	51	16.5	105	1.5
90 x 80 PN10/16	11	FL 615 418	204	72	16.5	130	2.5
110 x 100 PN10/16	11	FL 615 419	224	87	16.5	150	3.2
125 x 100 PN10/16	11	FL 615 605	224	101	16.5	160	3.3
160 x 150 PN10/16	11	FL 615 421	288	127	20.5	190	6.1
180 x 150 PN10/16	11	FL 615 927	288	123	20.5	200	6.7
225 x 200 PN10	11	FL 615 607	343	180	20.5	225	9.1

Maximum continuous operating pressure SDR 11 - 16 bar water (EN 12201-3)  
 Drilled to EN 1092-1:2007 Table 13  
 Note: Loose Backing Ring not required for these items

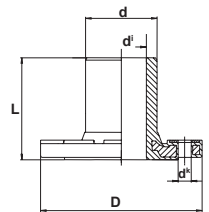

## FULL FACED REDUCED FLANGES



Size (mm)	SDR	Product Code	D (mm)	d <sub>i</sub> (mm)	d <sub>k</sub> (mm)	L (mm)	Weight (kg)
110 x 80 PN10/16	11	FL 616 065	204	16.5	161	160	3.5
160 x 100 PN10/16	11	FL 616 241	224	16.5	180	180	4.1

Maximum continuous operating pressure SDR 11 - 16 bar water (EN 12201-3)  
 Drilled to EN 1092-1:2007 Table 13  
 Note: Loose Backing Ring not required for these items  
 Additional washers are necessary

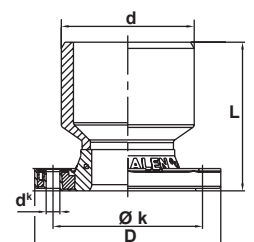

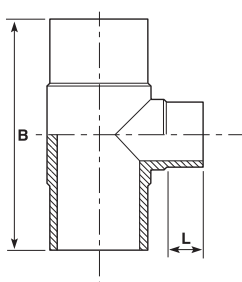
**REDUCED BRANCH  
TEES**

Size (mm)	SDR 11 Code	SDR 17 Code	L (mm)	B (mm)	SDR 11 Weight (kg)	SDR 17 Weight (kg)
63 x 32	40 378 415	-	228	46	0.3	-
63 x 50	40 378 444	-	215	56	0.3	-
75 x 32	40 378 416	-	260	50	0.5	-
75 x 50	40 378 372	-	260	55	0.5	-
75 x 63	40 378 445	-	255	63	0.8	-
90 x 50	40 378 446	40 377 446	303	60	0.6	0.6
90 x 63	40 378 459	40 377 459	303	65	0.9	0.7
90 x 75	40 378 471	40 377 471	272	68	0.8	1.0
110 x 63	40 378 460	40 377 460	316	62	1.5	1.1
110 x 75	40 378 472	40 377 472	309	70	1.2	0.9
110 x 90	40 378 483	40 377 483	320	78	1.5	1.1
125 x 90	40 378 484	40 377 484	320	82	1.6	1.1
125 x 110	40 378 493	40 377 493	341	83	1.8	1.2
140 x 63	40 378 462	40 377 462	386	77	1.9	1.3
140 x 75	40 378 474	40 377 474	386	78	1.3	1.3
140 x 90	40 378 485	40 377 485	388	87	1.9	1.4
140 x 110	40 378 494	40 377 494	388	95	2.2	2.2
160 x 63	40 378 463	40 377 463	424	72	3.3	2.0
160 x 75	40 378 475	40 377 475	424	73	2.7	1.9
160 x 90	40 378 486	40 377 486	424	84	2.9	2.6
160 x 110	40 378 495	40 377 495	425	93	2.9	2.7
180 x 90	40 378 487	40 377 487	460	85	3.5	2.5
180 x 110	40 378 496	40 377 496	460	95	3.3	2.5
180 x 125	40 378 505	40 377 505	430	100	3.4	2.5
180 x 140	40 378 513	40 377 513	460	104	3.6	2.6
180 x 160	40 378 520	40 377 520	460	110	6.1	3.1
200 x 63	40 378 465	40 377 465	500	70	4.7	2.8
200 x 90	40 378 488	40 377 488	500	82	6.5	2.9
200 x 110	40 378 497	40 377 497	500	91	6.5	3.3
200 x 125	40 378 506	40 377 506	500	100	6.6	3.4
200 x 160	40 378 521	40 377 521	500	104	4.9	3.6
225 x 75	40 378 478	40 377 478	555	70	8.5	4.6
225 x 90	40 378 489	40 377 489	535	82	8.5	6.5
225 x 110	40 378 498	40 377 498	522	92	8.3	6.5
225 x 125	40 378 507	40 377 507	522	93	6.6	4.5
225 x 140	40 378 515	40 377 515	535	105	7.9	4.6
225 x 160	40 378 522	40 377 522	522	109	6.9	7.3
225 x 180	40 378 528	40 377 528	560	105	8.0	7.2
250 x 110	40 378 499	40 377 499	600	91	8.0	6.1
250 x 160	40 378 523	40 377 523	600	104	7.9	6.4
250 x 180	40 378 529	40 377 529	600	105	18.2	11.9
315 x 90	40 378 492	40 377 492	700	82	8.6	5.7
315 x 110	40 378 501	40 377 501	700	90	8.6	5.7
315 x 160	40 378 525	40 377 525	700	106	12.4	10.0
315 x 180	40 378 531	40 377 531	700	107	14.5	7.9
315 x 200	40 378 536	40 377 536	700	120	15.5	8.3
315 x 225	40 378 540	40 377 540	700	120	16.9	8.7
315 x 250	40 378 543	40 377 543	695	130	18.3	9.9

Maximum continuous operating pressure SDR 11 - 16 bar water (EN 12201-3)

Maximum continuous operating pressure SDR 17 - 10 bar water (EN 12201-3)

*Note:* Some fittings will be produced from short spigots and pipped.

## FLANGED BRANCH TEES

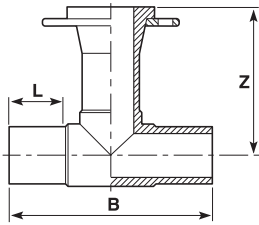

Size (mm)	SDR 11 Code	SDR 17 Code	L (mm)	B (mm)	Z (mm)	SDR 11 Weight (kg)	SDR 17 Weight (kg)
63 x 50 PN16	40 350 311	-	240	67	200	1.5	-
90 x 80 PN16	40 351 313	40 363 313	310	79	165	1.7	1.2
110 x 80 PN16	40 351 314	40 363 314	326	87	289	3.0	2.1
125 x 80 PN16	40 351 315	40 363 315	375	92	260	2.4	1.7
160 x 80 PN16	40 351 317	40 363 317	419	103	330	4.9	3.4
180 x 80 PN16	40 351 318	40 363 318	509	120	335	9.6	6.7
225 x 80 PN16	40 351 320	40 363 320	550	130	492	13.8	9.7
250 x 80 PN16	40 351 321	40 363 321	687	130	580	20.7	14.5
315 x 80 PN16	40 351 323	40 363 323	870	150	740	37.1	26.0
90 x 100 PN16	40 352 313	40 364 313	310	79	240	1.7	1.2
110 x 100 PN16	40 352 314	40 364 314	326	87	175	3.0	2.1
125 x 100 PN16	40 352 315	40 364 315	372	92	215	3.9	1.7
160 x 100 PN16	40 352 317	40 364 317	419	103	332	6.5	4.6
180 x 100 PN16	40 352 318	40 364 318	509	110	290	9.6	6.7
225 x 100 PN16	40 352 320	40 364 320	550	130	494	14.0	9.7
250 x 100 PN16	40 352 321	40 364 321	687	130	520	20.7	14.5
315 x 100 PN16	40 352 323	40 364 323	830	150	680	42.1	29.5
180 x 150 PN16	40 353 318	40 365 318	509	110	230	9.6	6.7
225 x 150 PN16	40 353 320	40 365 320	550	130	363	15.8	11.1
250 x 150 PN16	40 353 321	40 365 321	687	130	410	21.7	15.2
315 x 150 PN16	40 353 323	40 365 323	870	150	570	43.1	30.2

Maximum continuous operating pressure SDR 11 - 16 bar water (EN 12201-3)

Maximum continuous operating pressure SDR 17 - 10 bar water (EN 12201-3)

Drilled to BS EN 1092-1:2007 Table 13.

Note: Sizes 250 and 315mm have sections of pipe butt-fused to the moulding.

## 90° FORMED BENDS

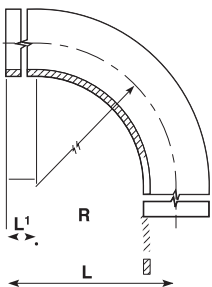

Size (mm)	SDR 11 Code	SDR 17 Code	Min L (mm)	Min L <sup>1</sup> (mm)	R/D	SDR 11 Weight (kg)	SDR 17 Weight (kg)
90	40 371 313	40 370 313	300	150	1.5	1.1	0.7
110	40 371 314	40 370 314	380	150	1.5	1.1	0.7
125	40 371 315	40 370 315	400	150	1.5	2.8	1.9
160	40 371 317	40 370 317	480	150	1.5	5.5	3.7
180	40 371 318	40 370 318	530	150	1.5	7.6	5.2
200	40 371 319	40 370 319	560	150	1.5	9.9	6.7
225	40 371 320	40 370 320	590	150	1.5	13.1	8.8
250	40 371 321	40 370 321	730	250	1.5	20.2	13.6
315	40 371 323	40 370 323	900	300	1.5	39.2	26.5
355	40 371 324	40 370 324	1000	300	1.5	55.1	37.4
400	40 371 325	40 370 325	1050	300	1.5	72.7	49.1
450	40 371 326	40 370 326	1150	300	1.5	100.6	68.0
500	40 371 327	40 370 327	1300	350	1.5	140.9	95.3
560	40 371 328	40 370 328	1350	350	1.5	181.2	122.5
630	40 371 329	40 370 329	1600	350	1.5	275.6	186.4

Maximum continuous operating pressure SDR 11 - 16 bar water (EN 12201-3)

Maximum continuous operating pressure SDR 17 - 10 bar water (EN 12201-3)



### 45° FORMED BENDS

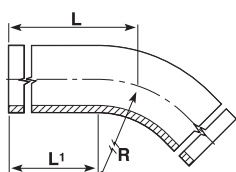

Size (mm)	SDR 11 Code	SDR 17 Code	Min L (mm)	Min L <sup>1</sup> (mm)	R/D	SDR 11 Weight (kg)	SDR 17 Weight (kg)
90	40 376 313	40 375 313	220	150	1.5	0.6	0.6
110	40 376 314	40 375 314	240	150	1.5	1.0	1.0
125	40 376 315	40 375 315	250	150	1.5	1.9	1.3
160	40 376 317	40 375 317	330	150	1.5	4.2	2.8
180	40 376 318	40 375 318	350	150	1.5	5.6	3.8
200	40 376 319	40 375 319	360	150	1.5	7.1	4.8
225	40 376 320	40 375 320	380	150	1.5	9.4	6.4
250	40 376 321	40 375 321	490	250	1.5	15.0	10.1
315	40 376 323	40 375 323	560	300	1.5	27.1	18.4
355	40 376 324	40 375 324	630	300	1.5	38.7	26.3
400	40 376 325	40 375 325	670	300	1.5	52.2	35.3
450	40 376 326	40 375 326	750	300	1.5	74.1	50.1
500	40 376 327	40 375 327	900	350	1.5	109.9	74.4
560	40 376 328	40 375 328	950	350	1.5	145.2	98.2
630	40 376 329	40 375 329	1000	350	1.5	193.5	130.9

Maximum continuous operating pressure SDR 11 - 16 bar water (EN 12201-3)

Maximum continuous operating pressure SDR 17 - 10 bar water (EN 12201-3)

### END CAPS

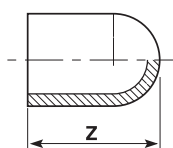

Size (mm)	SDR 11 Code	SDR 17 Code	Z (mm)	SDR 11 Weight (kg)	SDR 17 Weight (kg)
20	40 233 306	-	58	0.1	-
25	40 233 307	-	65	0.1	-
32	40 233 308	-	56	0.1	-
40	40 233 309	-	61	0.1	-
50	40 233 310	-	71	0.1	-
63	40 233 311	-	84	0.1	-
75	40 234 312	-	94	0.1	0.1
90	40 234 313	40 232 313	109	0.2	0.2
110	40 234 314	40 232 314	122	0.4	0.3
125	40 234 315	40 232 315	128	0.5	0.4
140	40 234 316	40 232 316	136	0.7	0.5
160	40 234 317	40 232 317	156	1.1	0.7
180	40 234 318	40 232 318	167	1.4	1.0
220	40 234 319	40 232 319	179	1.9	1.3
225	40 234 320	40 232 320	203	2.7	1.8
250	40 234 321	40 232 321	217	3.6	2.4
280	40 234 322	40 232 322	239	5.0	3.3
315	40 234 323	40 232 323	256	6.9	4.6
355	40 234 324	40 232 324	291	9.7	6.6
400	40 234 325	40 232 325	316	13.7	9.2

Maximum continuous operating pressure SDR11 - 16 bar water (EN 12201-3)

Maximum continuous operating pressure SDR17 - 10 bar water (EN 12201-3)

## 22½° FORMED BENDS

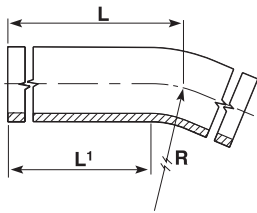
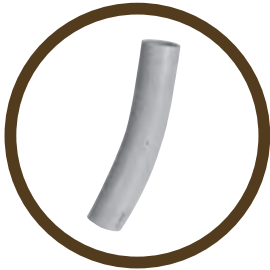

Size (mm)	SDR 11 Code	SDR 17 Code	Min L (mm)	Min L <sup>1</sup> (mm)	R/D	SDR 11 Weight (kg)	SDR 17 Weight (kg)
90	40 381 313	40 380 313	210	150	1.5	0.8	0.6
110	40 381 314	40 380 314	220	150	1.5	1.3	0.9
125	40 381 315	40 380 315	235	150	1.5	1.8	1.2
160	40 381 317	40 380 317	260	150	1.5	3.3	2.2
180	40 381 318	40 380 318	280	150	1.5	4.5	3.1
200	40 381 319	40 380 319	310	150	1.5	6.2	4.2
225	40 381 320	40 380 320	350	150	1.5	8.8	6.0
250	40 381 321	40 380 321	430	250	1.5	13.4	9.0
315	40 381 323	40 380 323	500	300	1.5	24.6	16.7
355	40 381 324	40 380 324	590	300	1.5	36.9	25.0
400	40 381 325	40 380 325	650	300	1.5	51.6	34.9
450	40 381 326	40 380 326	700	300	1.5	70.5	47.6
500	40 381 327	40 380 327	750	350	1.5	93.1	63.0
560	40 381 328	40 380 328	800	350	1.5	124.5	84.1
630	40 381 329	40 380 329	850	350	1.5	167.5	113.3

Maximum continuous operating pressure SDR 11 - 16 bar water (EN 12201-3)  
 Maximum continuous operating pressure SDR 17 - 10 bar water (EN 12201-3)

## 11¼° FORMED BENDS

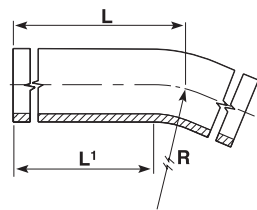

Size (mm)	SDR 11 Code	SDR 17 Code	Min L (mm)	Min L <sup>1</sup> (mm)	R/D	SDR 11 Weight (kg)	SDR 17 Weight (kg)
90	40 373 313	40 372 313	210	150	1.5	0.8	0.6
110	40 373 314	40 372 314	220	150	1.5	1.3	0.9
125	40 373 315	40 372 315	235	150	1.5	1.8	1.2
160	40 373 317	40 372 317	260	150	1.5	3.3	2.2
180	40 373 318	40 372 318	280	150	1.5	4.5	3.1
200	40 373 319	40 372 319	310	150	1.5	6.2	4.2
225	40 373 320	40 372 320	350	150	1.5	8.8	6.0
250	40 373 321	40 372 321	430	250	1.5	13.4	9.0
315	40 373 323	40 372 323	500	300	1.5	24.7	16.7
355	40 373 324	40 372 324	590	300	1.5	37.0	25.1
400	40 373 325	40 372 325	650	300	1.5	51.7	34.9
450	40 373 326	40 372 326	700	300	1.5	70.6	47.7
500	40 373 327	40 372 327	750	350	1.5	93.3	63.2
560	40 373 328	40 372 328	800	350	1.5	124.7	84.3
630	40 373 329	40 372 329	850	350	1.5	167.9	113.6

Maximum continuous operating pressure SDR 11 - 16 bar water (EN 12201-3)  
 Maximum continuous operating pressure SDR 17 - 10 bar water (EN 12201-3)

## → Ayshire Wastewater Network

More than 10km of Excel PE piping was specified for a new wastewater network in Ayrshire that will provide additional capacity for storm and floodwaters protecting properties from flooding and safeguarding the environment.

The contractor and project management team from Morrison Black & Veatch Joint Venture (MBV) created a new waste water network as part of a multi-million investment programme to help protect local coastal waters and rivers.



Explains Alastair Graham, Senior Project Manager at Scottish Water: “Combined sewer overflows (CSOs) have traditionally provided

an important failsafe to prevent storm water and domestic sewage from backing up and causing floods following heavy rainfall, however, the new waste water network will provide an equally efficient but much more environmentally friendly solution to this issue.”

### THREE PART APPROACH

The project was divided into three parts: WP6.1 (Kilmarnock), WP6.2 (rising main from Gatehead up to and including a new inlet works at Meadowhead WWTW) and WP6.3 (Irvine). Within WP6.2, 4.5km of 1000mm PE pipe was laid under largely arable land in the rural areas surrounding the Meadowhead WWTW, while 2km of 900mm PE pipe will

be installed between the Drybridge Rail crossing (trenchless crossing) and Meadowhead WWTW. GPS has supplied the entire PE piping requirement for this project and all sizes have been supplied in SDR26 to accommodate the flow rates and durability required by the specification.

The pipe installation in the arable land areas of the project involved straightforward excavation of open trenches and



lengths of the PE pipe were welded together and lowered into the trench, which then was backfilled. In the areas below Irvine and Kilmarnock, the installation was much

more challenging as existing services had to be diverted and where services are very congested or there are rivers or dual carriageways, the contractor constructed tunnels. Within the tunnelled areas, the PE pipe was substituted for ductile iron pipe and these sections will be joined to the PE pipe using flange connectors.

Adds Stewart Cochran from MBV:

“This is a complex installation but, once completed in 2012, it will provide a durable and environmentally responsible approach to managing waste water levels following heavy rainfall.”

# PUPPED FITTINGS

PUPPED FITTINGS FOR POTABLE & NON-POTABLE WATER



## FEATURES & BENEFITS

- Deliver cost savings up to 30%
- Fabrications can be produced offsite – reducing the installation footprint
- Manufactured in a clean process environment
- Improve productivity – through a “just in time” philosophy
- Manufactured to an industry Kitemark
- Available in SDR11 and SDR17 in sizes up to 1200mm

### Available in an extensive range of fittings configurations

- Reducers
- 90° and 45° Elbows
- Equal Tees
- Large Diameter Equal Tees
- Reduced Branch Tees
- Large Diameter Reduced Branch Tees
- Stub Flange Assemblies
- Flanged Short Branch Tees
- SlimFlange Assemblies
- Special Flange Assemblies PN16
- 90°, 45°, 22½°, 11¼° Mitred Elbows

## DID YOU KNOW?

Flanges can be prefabricated away from site and delivered at the point of installation

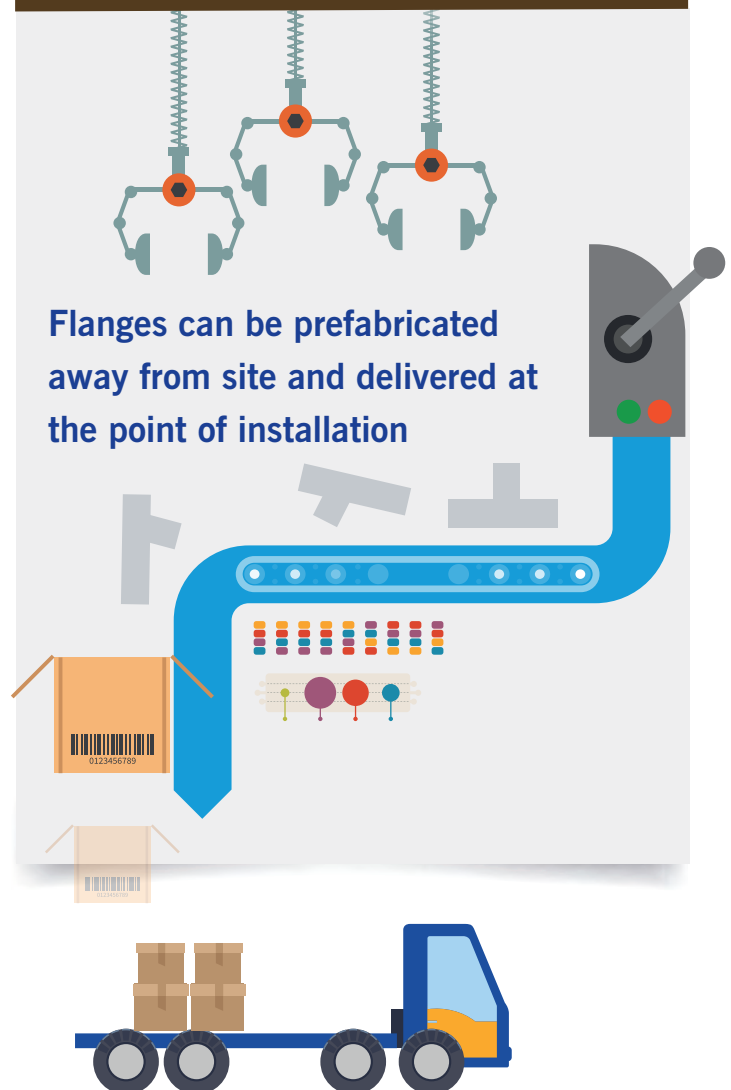

# ELONGATED SPIGOT FITTINGS FOR POTABLE & NON-POTABLE WATER

## REDUCERS

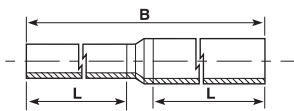
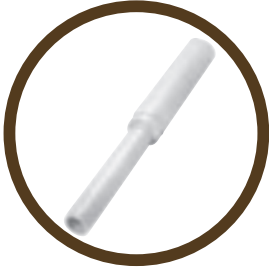

\* Replace XX with material/code required:

- PE100 Black = 40
- PE100 Blue = 41

Size (mm)	SDR 11 Code*	SDR 17 Code*	B (mm)	L (mm)	SDR 11 Weight (kg)	SDR 17 Weight (kg)
90 x 63	XX 323 459	-	1182	500	1.9	-
110 x 90	XX 323 483	XX 322 483	1186	500	3.2	2.2
125 x 63	XX 323 461	-	1200	500	3.2	-
125 x 90	XX 323 484	XX 322 484	1202	500	3.6	2.6
160 x 90	XX 323 486	XX 322 486	1254	500	5.7	3.9
160 x 110	XX 323 495	XX 322 495	1254	500	6.3	4.3
160 x 125	XX 323 504	XX 322 504	1254	500	6.9	4.6
180 x 90	XX 323 487	XX 322 487	1245	500	6.8	4.7
180 x 125	XX 323 505	XX 322 505	1245	500	8.0	5.4
200 x 160	XX 323 506	XX 322 506	1277	500	11.0	7.5
225 x 160	XX 323 507	XX 322 507	1295	500	13.1	9.0
250 x 125	XX 323 508	XX 322 508	TBC	500	10.2	6.9
250 x 180	XX 323 529	XX 322 529	1316	500	16.7	11.3
315 x 250	XX 323 543	XX 322 543	1365	500	29.3	20.0
315 x 280	XX 323 545	XX 322 545	1365	500	32.1	21.7
355 x 125	XX 323 571	XX 322 571	TBC	500	18.5	12.6
355 x 180	XX 323 532	XX 322 532	TBC	500	20.7	14.1
355 x 225	XX 323 541	XX 322 541	TBC	500	23.1	15.7
355 x 250	XX 323 544	XX 322 544	1390	500	38.2	23.9
355 x 280	XX 323 546	XX 322 546	1390	500	39.9	27.2
355 x 315	XX 323 547	XX 322 547	1390	500	42.4	30.0
400 x 180	XX 323 560	XX 322 560	TBC	500	25.1	17.1
400 x 250	XX 323 563	XX 322 563	TBC	500	29.0	19.7
400 x 280	XX 323 564	XX 322 564	1415	500	48.0	34.6
400 x 315	XX 323 565	XX 322 565	1415	500	51.6	36.0
400 x 355	XX 323 566	XX 322 566	1415	500	55.2	40.4
450 x 250	XX 323 573	XX 322 573	TBC	1000	69.3	46.9
450 x 280	XX 323 584	XX 322 584	2390	1000	89.6	61.3
450 x 315	XX 323 574	XX 322 574	2390	1000	95.6	65.1
450 x 355	XX 323 575	XX 322 575	2400	1000	103.4	70.2
450 x 400	XX 323 576	XX 322 576	2400	1000	113.2	76.9
500 x 355	XX 323 579	XX 322 579	2430	1000	120.8	82.4
500 x 400	XX 323 580	XX 322 580	2430	1000	130.7	88.8
500 x 450	XX 323 581	XX 322 581	2430	1000	143.3	97.2
560 x 450	XX 323 586	XX 322 586	2470	1000	167.1	113.7
560 x 500	XX 323 594	XX 322 594	2470	1000	181.2	123.0
630 x 500	XX 323 599	XX 322 599	2510	1000	213.6	145.4
630 x 560	XX 323 595	XX 322 595	2520	1000	232.2	157.7

Maximum continuous operating pressure SDR 11 - 16 bar water (EN 12201-3)

Maximum continuous operating pressure SDR 17 - 10 bar water (EN 12201-3)

Dimensions of pupped fittings should be used subject to a +/- 5mm tolerance due to the nature of the fabrication process.

Standard pup leg lengths: 0.5m in sizes up to 400mm; 1.0m in sizes 450mm to 1200mm.

Additional bespoke large diameter fabricated fittings are available to order – please contact our Sales Office for further information.

## 90° ELBOWS

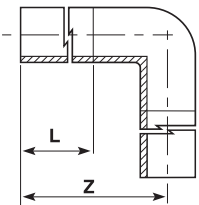

Size (mm)	SDR 11 Code*	SDR 17 Code*	L (mm)	Z (mm)	SDR 11 Weight (kg)	SDR 17 Weight (kg)
90	XX 309 313	XX 308 313	500	642	2.8	1.9
110	XX 309 314	XX 308 314	500	662	4.3	3.0
125	XX 309 315	XX 308 315	500	669	5.6	3.8
160	XX 309 317	XX 308 317	500	733	10.1	6.9
180	XX 309 318	XX 308 318	500	747	12.9	8.8
200	XX 309 319	XX 308 319	500	762	16.6	11.3
225	XX 309 320	XX 308 320	500	781	21.3	14.6
250	XX 309 321	XX 308 321	500	793	27.4	18.9
280	XX 309 322	XX 308 322	500	830	35.5	24.6
315	XX 309 323	XX 308 323	500	870	47.3	33.4
355	XX 309 324	XX 308 324	500	1400	83.6	63.6

Maximum continuous operating pressure SDR 11 - 16 bar water (EN 12201-3)

Maximum continuous operating pressure SDR 17 - 10 bar water (EN 12201-3)

\* Replace XX with material/code required: ■ PE100 Black = 40 ■ PE100 Blue = 41

## 45° ELBOWS

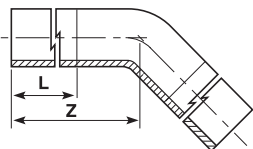
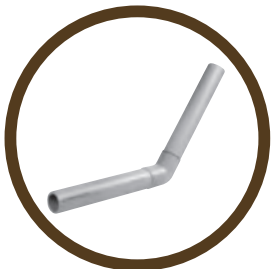

Size (mm)	SDR 11 Code*	SDR 17 Code*	L (mm)	Z (mm)	SDR 11 Weight (kg)	SDR 17 Weight (kg)
90	XX 315 313	XX 314 313	500	605	2.6	1.8
110	XX 315 314	XX 314 314	500	621	4.0	2.8
125	XX 315 315	XX 314 315	500	637	5.3	3.6
160	XX 315 317	XX 314 317	500	690	9.5	6.4
180	XX 315 318	XX 314 318	500	696	12.0	8.2
200	XX 315 319	XX 314 319	500	707	15.3	10.4
225	XX 315 320	XX 314 320	500	710	19.4	13.3
250	XX 315 321	XX 314 321	500	720	24.7	16.9
280	XX 315 322	XX 314 322	500	727	31.1	21.6
315	XX 315 323	XX 314 323	500	750	40.6	28.1
355	XX 315 324	XX 314 324	500	1120	75.1	50.9

Maximum continuous operating pressure SDR 11 - 16 bar water (EN 12201-3)

Maximum continuous operating pressure SDR 17 - 10 bar water (EN 12201-3)

\* Replace XX with material/code required: ■ PE100 Black = 40 ■ PE100 Blue = 41

Dimensions of pupped fittings should be used subject to a +/- 5mm tolerance due to the nature of the fabrication process.

Standard pup leg lengths: 0.5m in sizes up to 400mm; 1.0m in sizes 450mm to 1200mm.

Additional bespoke large diameter fabricated fittings are available to order – please contact our Sales Office for further information.

**EQUAL TEES**

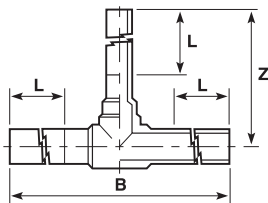

Size (mm)	SDR 11 Code*	SDR 17 Code*	L (mm)	B (mm)	Z (mm)	SDR 11 Weight (kg)	SDR 17 Weight (kg)
90	XX 321 313	XX 320 313	500	1277	637	4.2	2.9
110	XX 321 314	XX 320 314	500	1321	662	6.4	4.4
125	XX 321 315	XX 320 315	500	1350	676	8.4	5.8
160	XX 321 317	XX 320 317	500	1413	706	14.4	9.9
180	XX 321 318	XX 320 318	500	1528	760	19.6	13.5
200	XX 321 319	XX 320 319	500	1505	753	24.1	16.4
225	XX 321 320	XX 320 320	500	1559	778	31.7	21.8
250	XX 321 321	XX 320 321	500	1582	791	38.5	26.0
280	XX 321 322	XX 320 322	500	1622	812	49.6	33.9
315	XX 321 323	XX 320 323	500	1690	851	65.3	44.1
355	XX 321 324	XX 320 324	500	1829	914	87.5	59.6
400	XX 321 325	XX 320 325	500	1913	957	114.7	78.5

Maximum continuous operating pressure SDR 11 - 16 bar water (EN 12201-3)

Maximum continuous operating pressure SDR 17 - 10 bar water (EN 12201-3)

\* Replace XX with material/code required: ■ PE100 Black = 40 ■ PE100 Blue = 41

**LARGE DIAMETER EQUAL TEE**

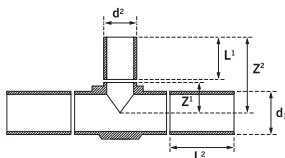

Size (mm)	SDR 11 Code*	SDR 17 Code*	Z <sup>1</sup> (mm)	Z <sup>2</sup> (mm)	L <sup>1</sup> (mm)	SDR 11 Weight (kg)	SDR 17 Weight (kg)
450	XX 321 326	XX 320 326	485	1485	1000	156.7	109.8
500	XX 321 327	XX 320 327	530	1530	1000	199.0	137.5
560	XX 321 328	XX 320 328	705	1705	1000	279.3	195.5
630	XX 321 329	XX 320 329	740	1740	1000	361.9	253.4
710	XX 321 330	XX 320 330	780	1780	1000	471.3	330.1
800	-	XX 320 332	826	1826	1000	-	428.5
900	-	XX 320 333	882	1882	1000	-	580.6
1000	-	XX 320 334	932	1932	1000	-	738.9
1200	-	XX 320 335	1033	2033	1000	-	1121.6

Maximum continuous operating pressure SDR 11 - 16 bar water (EN 12201-3)

Maximum continuous operating pressure SDR 17 - 10 bar water (EN 12201-3)

Larger sizes and different SDRs and other configurations including flanged branches are available, please contact our Sales Office for further information.

Dimensions are approximate and given as a guide only.

Bespoke fabrication, dimensions by agreement

\* Replace XX with material/code required: ■ PE100 Black = 40 ■ PE100 Blue = 41

Dimensions of pupped fittings should be used subject to a +/- 5mm tolerance due to the nature of the fabrication process.

Standard pup leg lengths: 0.5m in sizes up to 400mm; 1.0m in sizes 450mm to 1200mm.

Additional bespoke large diameter fabricated fittings are available to order – please contact our Sales Office for further information.

## REDUCED BRANCH TEES

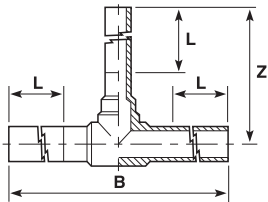

Size (mm)	SDR 11 Code*	SDR 17 Code*	L (mm)	B (mm)	Z (mm)	SDR 11 Weight (kg)	SDR 17 Weight (kg)
110 x 90	XX 347 314	XX 356 314	500	1321	848	4.8	3.2
125 x 90	XX 347 315	XX 356 315	500	1350	878	6.0	4.2
160 x 90	XX 347 317	XX 356 317	500	1413	927	9.8	6.7
180 x 90	XX 347 318	XX 356 318	500	1528	1207	14.6	10.1
200 x 90	XX 347 319	XX 356 319	500	1505	1251	18.1	12.4
225 x 90	-	XX 356 320	500	1559	1294	23.6	16.4
250 x 90	XX 347 321	XX 356 321	500	1582	1554	29.9	20.2
280 x 90	XX 347 322	XX 356 322	500	1622	1673	40.6	27.7
315 x 90	XX 347 323	XX 356 323	500	1690	1732	52.6	35.4
355 x 90	XX 347 324	XX 356 324	500	1698	1942	64.4	53.8
400 x 90	XX 347 325	XX 356 325	500	1730	1991	80.0	68.0
180 x 125	XX 348 318	XX 357 318	500	1528	1005	14.9	10.3
200 x 125	XX 348 319	XX 357 319	500	1505	1277	19.4	13.3
225 x 125	-	XX 357 320	500	1559	1308	24.9	17.1
250 x 125	XX 348 321	XX 357 321	500	1582	1352	30.2	20.3
280 x 125	XX 348 322	XX 357 322	500	1622	1687	41.9	28.6
315 x 125	XX 348 323	XX 357 323	500	1690	1746	55.5	37.5
355 x 125	XX 348 324	XX 357 324	500	1698	1740	64.7	54.0
400 x 125	XX 348 325	XX 357 325	500	1730	2128	79.8	68.8
225 x 180	-	XX 358 320	500	1559	1063	25.8	17.8
250 x 180	XX 349 321	XX 358 321	500	1582	1107	30.7	20.7
280 x 180	XX 349 322	XX 358 322	500	1622	1442	42.8	29.0
315 x 180	XX 349 323	XX 358 323	500	1690	1501	56.0	37.9
355 x 180	XX 349 324	XX 358 324	500	1698	1495	65.2	54.4
400 x 180	XX 349 325	XX 358 325	500	1730	1883	81.0	67.6
315 x 250	XX 335 323	XX 336 323	500	1690	1216	55.6	37.6
355 x 250	XX 335 324	XX 336 324	500	1698	1179	64.8	54.1
400 x 250	XX 335 325	XX 336 325	500	1730	1253	79.7	67.7

Maximum continuous operating pressure SDR 11 - 16 bar water (EN 12201-3)

Maximum continuous operating pressure SDR 17 - 10 bar water (EN 12201-3)

\* Replace XX with material/code required: ■ PE100 Black = 40 ■ PE100 Blue = 41

Dimensions of pupped fittings should be used subject to a +/- 5mm tolerance due to the nature of the fabrication process.

Standard pup leg lengths: 0.5m in sizes up to 400mm; 1.0m in sizes 450mm to 1200mm.

Additional bespoke large diameter fabricated fittings are available to order – please contact our Sales Office for further information.



### LARGE DIAMETER REDUCED BRANCH TEES



Size (mm)	SDR 11 Code*	SDR 17 Code*	L (mm)	B (mm)	Z (mm)	SDR 11 Weight (kg)	SDR 17 Weight (kg)
450 x 180	XX 349 326	XX 358 326	1000	2397	1406	139.4	95.7
450 x 250	XX 335 326	XX 336 326	1000	2467	1506	154.9	106.5
450 x 315	XX 809 326	XX 285 326	1000	2532	1556	172.8	119.2
500 x 180	XX 349 327	XX 358 327	1000	2397	1431	169.6	116.5
500 x 250	XX 335 327	XX 336 327	1000	2467	1531	186.0	128.0
500 x 315	XX 809 327	XX 285 327	1000	2532	1581	204.7	141.3
630 x 180	XX 349 329	XX 358 329	1000	2395	1496	262.5	180.0
630 x 250	XX 335 329	XX 336 329	1000	2465	1596	281.7	193.6
630 x 315	XX 809 329	XX 285 329	1000	2530	1646	303.1	208.8

\* Replace XX with material/code required:

- PE100 Black = 40
- PE100 Blue = 41

Maximum continuous operating pressure SDR 11 - 16 bar water (EN 12201-3)  
 Maximum continuous operating pressure SDR 17 - 10 bar water (EN 12201-3)  
 Larger sizes and different SDRs and other configurations including flanged branches are available, please contact our Sales Office for further information.  
 Dimensions are approximate and given as a guide only.

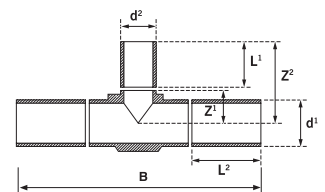

### STUB FLANGE ASSEMBLIES

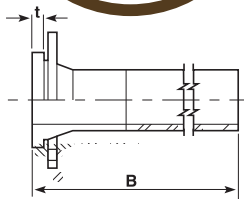

Size (mm)	SDR 11 Code*	SDR 17 Code*	B (mm)	t SDR 11 (mm)	t SDR 17 (mm)	SDR 11 Weight (kg)	SDR 17 Weight (kg)	Metric Bolt Size**
*63 x 50	51 327 311	-	606	14	-	1.71	-	M16
*63 x 80	51 327 459	-	606	14	-	1.71	-	M16
90 x 80	XX 327 313	XX 326 313	640	17	17	3.94	2.4	M16
110 x 100	XX 327 314	XX 326 314	660	18	18	5.01	3.2	M16
125 x 100	XX 327 315	XX 326 315	683	25	25	5.74	3.7	M16
160 x 150	XX 327 317	XX 326 317	708	25	25	10.31	6.4	M20
180 x 150	XX 327 318	XX 326 318	702	30	30	11.53	7.5	M20
200 x 200	XX 327 319	XX 326 319	700	32	32	14.94	9.8	M20
225 x 200	XX 327 320	XX 326 320	621	32	32	16.47	10.9	M20
250 x 250	XX 327 321	XX 326 321	620	35	25	22.63	15.1	M24
280 x 250	XX 327 322	XX 326 322	619	35	25	24.17	16.0	M24
315 x 300	XX 327 323	XX 326 323	668	35	25	32.44	23.7	M24
355 x 350	XX 327 324	XX 326 324	687	40	30	42.89	31.7	M24
400 x 400	XX 327 325	XX 326 325	695	46	33	57.48	43.0	M27
450 x 450	XX 327 326	XX 326 326	1139	60	46	105.09	73.7	M27
500 x 500	XX 327 327	XX 326 327	1138	60	46	124.31	92.0	M30
560 x 600	XX 327 328	XX 326 328	1141	60	50	178.28	147.1	M33
630 x 600	XX 327 329	XX 326 329	1143	60	50	193.45	154.5	M33
710 x 700	XX 327 330	XX 326 330	1150	60	50	227.54	185.1	M33
800 x 800	-	XX 326 332	1150	-	52	-	237.9	M36
900 x 900	-	XX 326 333	1155	-	55	-	298.0	M36
1000 x 1000	-	XX 326 334	1180	-	60	-	396.4	M39
1200 x 1200	-	XX 326 335	1190	-	70	-	556.8	M45

Maximum continuous operating pressure SDR 11 - 16 bar water (EN 12201-3)  
 Maximum continuous operating pressure SDR 17 - 10 bar water (EN 12201-3)  
 \* PE80 only  
 With backing ring drilled to BS EN 1092-1:2007 Table 13.  
 All sizes up to and including 315mm to be supplied with a gasket  
 Other lengths (B) available - please contact our Sales office for further information.

\* Replace XX with material/code required: ■ PE100 Black = 40 ■ PE100 Blue = 41

Dimensions of pupped fittings should be used subject to a +/- 5mm tolerance due to the nature of the fabrication process.

Standard pup leg lengths: 0.5m in sizes up to 400mm; 1.0m in sizes 450mm to 1200mm.

Additional bespoke large diameter fabricated fittings are available to order – please contact our Sales Office for further information.

## FLANGED SHORT BRANCH TEES

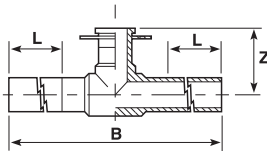

Size (mm)	SDR 11 Code*	SDR 17 Code*	L (mm)	B (mm)	Z (mm)	SDR 11 Weight (kg)	SDR 17 Weight (kg)
90 x 80	XX 3XX 313	XX 310 313	500	1277	277	3.0	2.2
110 x 80	XX 3XX 314	XX 310 314	500	1320	298	4.5	3.1
125 x 80	XX 3XX 315	XX 310 315	500	1340	310	5.8	4.2
160 x 80	XX 3XX 317	XX 310 317	500	1412	328	9.5	6.6
180 x 80	XX 3XX 318	XX 310 318	500	1420	340	12.9	9.1
200 x 80	XX 3XX 319	XX 310 319	500	1558	366	17.1	11.8
225 x 80	XX 3XX 320	XX 310 320	500	1558	366	19.9	13.7
250 x 80	XX 3XX 321	XX 310 321	500	1706	493	29.0	19.9
280 x 80	XX 3XX 322	XX 310 322	500	1706	493	36.1	25.0
315 x 80	XX 3XX 323	XX 310 323	500	1806	543	47.9	33.1
90 x 100	XX 342 313	XX 311 313	500	1277	445	3.5	2.4
110 x 100	XX 342 314	XX 311 314	500	1321	345	4.8	3.3
125 x 100	XX 342 315	XX 311 315	500	1350	359	6.3	4.4
160 x 100	XX 342 317	XX 311 317	500	1412	378	10.0	7.3
180 x 100	XX 342 318	XX 311 318	500	1430	406	13.6	9.9
200 x 100	XX 342 319	XX 311 319	500	1522	450	19.2	14.1
225 x 100	XX 342 320	XX 311 320	500	1522	450	22.0	16.0
250 x 100	XX 342 321	XX 311 321	500	1741	554	30.1	20.8
280 x 100	XX 342 322	XX 311 322	500	1741	554	37.4	26.0
315 x 100	XX 342 323	XX 311 323	500	1841	604	49.4	19.3
355 x 100	XX 342 324	XX 311 324	500	1841	604	62.5	43.4
160 x 150	XX 343 317	XX 312 317	500	1413	408	11.0	7.6
180 x 150	XX 343 318	XX 312 318	500	1528	462	15.4	10.7
200 x 150	XX 343 319	XX 312 319	500	1560	482	18.6	14.3
225 x 150	XX 343 320	XX 312 320	500	1560	482	21.4	16.2
250 x 150	XX 343 321	XX 312 321	500	1797	601	32.2	22.4
315 x 150	XX 343 323	XX 312 323	500	1897	651	52.1	36.3
355 x 150	XX 343 324	XX 312 324	500	1897	651	64.5	45.8

Maximum continuous operating pressure SDR 11 - 16 bar water (EN 12201-3)

Maximum continuous operating pressure SDR 17 - 10 bar water (EN 12201-3)

Flanged Branch PN16. SDR 17.6 is available in Yellow only.

Drilled to BS EN 1092-1:2007 Table 13.

\* Replace XX with material/code required: ■ PE100 Black = 40 ■ PE100 Blue = 41

Dimensions of pupped fittings should be used subject to a +/- 5mm tolerance due to the nature of the fabrication process.

Standard pup leg lengths: 0.5m in sizes up to 400mm; 1.0m in sizes 450mm to 1200mm.

Additional bespoke large diameter fabricated fittings are available to order – please contact our Sales Office for further information.

### SLIMFLANGE ASSEMBLIES

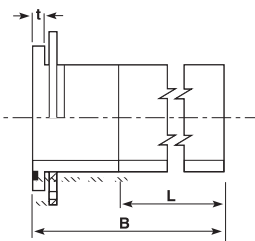

Size (mm)	SDR 11 Code*	SDR 17 Code*	L (mm)	B (mm)	t SDR 11 (mm)	t SDR 17 (mm)	SDR 11 Weight (kg)	SDR 17 Weight (kg)
250 x 200	XX 453 321	XX 452 321	500	620	31	27	9.0	8.0
315 x 250	XX 453 323	XX 452 323	500	620	35	30	14.0	12.0
355 x 300	XX 453 324	XX 452 324	500	620	40	35	21.0	19.0
400 x 350	XX 453 325	XX 452 325	500	620	44	38	31.0	29.0
450 x 400	XX 453 326	XX 452 326	1000	1120	49	42	38.0	35.0
500 x 450	XX 453 327	XX 452 327	1000	1120	53	45	47.0	43.0
560 x 500	XX 453 328	XX 452 328	1000	1120	59	50	58.0	53.0

Maximum continuous operating pressure SDR 11 - 16 bar water (EN 12201-3)  
 Maximum continuous operating pressure SDR 17 - 10 bar water (EN 12201-3)

The SlimFlange is a unique product and allows size-for-size connection of a PE pipeline to a metal flange without loss of nominal bore. It is only sold as a complete assembly.

Bolt kits are not supplied in the assembly. However, it is recommended that, to achieve the best performance, bolt kits within the assembly. However, it is recommended that, to achieve the best performance, bolt kits with washers of type form A (normal range) as per BS4320 are used.

The first size refers to the outside diameter of the PE pipe and the second to the nominal bore of the ductile iron pipe or fitting/valve.

SlimFlange Assemblies comprise of SlimFlange, galvanised mild steel backing ring and full faced gasket.  
 For other SDRs and drilling's please contact our Sales Office for further information.

\* Replace XX with material/code required: ■ PE100 Black = 40 ■ PE100 Blue = 41

### SLIMFLANGE BACKING RING

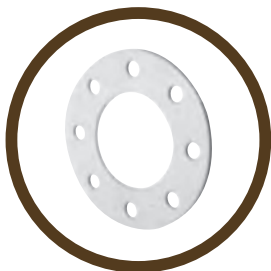

(For dimensional purpose only - not for sale individually)

Size (mm)	SDR	A (mm)	B (mm)	C (mm)	D (mm)	PCD P (mm)	No of Holes	Weight (kg)	Metric Bolt Size*
250 x 200	11 & 17	340	13	252	22	295	12	3.5	M20
315 x 250	11 only	405	15	301	26	355	12	5.2	M24
315 x 250	17 only	405	15	317	22	359	12	5.2	M20
355 x 300	11 & 17	460	20	358	27	410	12	9.0	M24
400 x 350	11 & 17	520	25	403	27	470	16	14.6	M24
450 x 400	11 & 17	580	25	453	30	525	16	17.1	M27
500 x 450	11 & 17	640	25	504	30	585	20	20.2	M27
560 x 500	11 & 17	715	25	564	33	650	20	25.1	M30

Drilled to BS EN 1092-1:2007 Table 13. Except for 315x250mm SDR 17

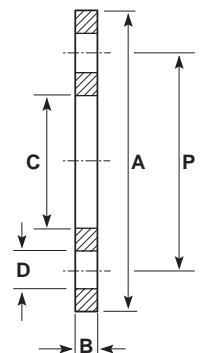

Dimensions of pupped fittings should be used subject to a +/- 5mm tolerance due to the nature of the fabrication process.  
 Standard pup leg lengths: 0.5m in sizes up to 400mm; 1.0m in sizes 450mm to 1200mm.  
 Additional bespoke large diameter fabricated fittings are available to order – please contact our Sales Office for further information.

## SPECIAL FLANGE ASSEMBLIES PN16

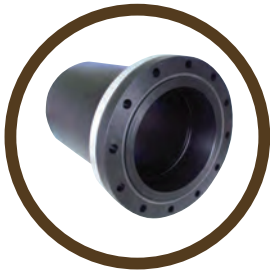

Size (mm)	SDR 11 Code*	SDR 17 Code*	L (mm)	Z (mm)	t (mm)	SDR 11 Weight (kg)	SDR 17 Weight (kg)
630 x 500	XX 456 329	XX 455 329	1000	1620	98	199.1	165.8
710 x 600	XX 456 330	XX 455 330	1000	1860	120	311.6	269.2
800 x 700	-	XX 455 332	1000	1900	135	-	337.1
900 x 800	-	XX 455 333	1000	1900	149	-	434.9
1000 x 900	-	XX 455 334	1000	1910	164	-	521.5
1200 x 1000	-	XX 455 335	1000	1930	180	-	669.7

Maximum continuous operating pressure SDR 11 - 16 bar water (EN 12201-3)

Maximum continuous operating pressure SDR 17 - 10 bar water (EN 12201-3)

<sup>1</sup> The first size refers to the outside diameter of the PE pipe and the second to the nominal bore of the ductile iron pipe or fitting.

Drilled to BS EN 1092-1:2007 Table 13.

\* Replace XX with material/code required: ■ PE100 Black = 40 ■ PE100 Blue = 41

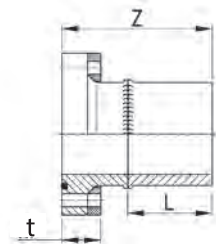

## 90° MITRED ELBOWS



Size (mm)	SDR 11 Code*	SDR 17 Code*	SDR 21 Code*	L (mm)	Z (mm)	SDR 11 Weight (kg)	SDR 17 Weight (kg)	SDR 21 Weight (kg)
90	XX 244 313	XX 243 313	-	500	617	2.4	1.6	-
110	XX 244 314	XX 243 314	-	500	643	3.9	2.7	-
125	XX 244 315	XX 243 315	-	500	663	5.0	4.0	-
160	XX 244 317	XX 243 317	XX 248 317	500	708	9.0	6.0	5.0
180	XX 244 318	XX 243 318	XX 248 318	500	734	12.0	8.0	7.0
200	XX 244 319	XX 243 319	XX 248 319	500	760	18.0	12.0	10.0
225	XX 244 320	XX 243 320	XX 248 320	500	793	20.0	14.0	11.0
250	XX 244 321	XX 243 321	XX 248 321	500	825	26.0	17.0	14.0
280	XX 244 322	XX 243 322	XX 248 322	500	864	32.0	22.0	17.0
315	XX 244 323	XX 243 323	XX 248 323	500	907	42.0	29.0	23.0
355	XX 244 324	XX 243 324	XX 248 324	500	962	56.0	38.0	30.0
400	XX 244 325	XX 243 325	XX 248 325	500	1020	75.0	51.0	39.0
450	XX 244 326	XX 243 326	XX 248 326	1000	1585	153.0	103.0	81.0
500	XX 244 327	XX 243 327	XX 248 327	1000	1650	195.0	132.0	102.0
560	XX 244 328	XX 243 328	XX 248 328	1000	1729	255.0	170.0	131.0
630	XX 244 329	XX 243 329	XX 248 329	1000	1820	335.0	230.0	177.0
710	XX 244 330	XX 243 330	XX 248 330	1000	1929	450.0	305.0	259.0
800	-	XX 243 332	XX 248 332	1000	2041	-	405.0	344.0
900	-	XX 243 333	XX 248 333	1000	2171	-	567.8	462.0
1000	-	XX 243 334	XX 248 334	1000	2301	-	730.8	595.0
1200	-	XX 243 335	XX 248 335	1000	2561	-	1152.0	940.0

Dimensions of pupped fittings should be used subject to a +/- 5mm tolerance due to the nature of the fabrication process. Standard pup leg lengths: 0.5m in sizes up to 400mm; 1.0m in sizes 450mm to 1200mm. Additional bespoke large diameter fabricated fittings are available to order – please contact our Sales Office for further information.

Maximum continuous operating pressure SDR 11 - 16 bar water (EN 12201-3)

Maximum continuous operating pressure SDR 17 - 10 bar water (EN 12201-3)

Maximum continuous operating pressure SDR21 - 8 bar water (EN 12201-3)

For water applications, de-rate the pressure rating of 22.5°, 45° and 90° mitred bends to 0.8 x the pipe rating from which it was made.

We can supply longer legs for some butt fusion machines or shorter (long spigot) for electrofusion.

R = Radius of curvature = approx 1.5 x D (the pipe size)

\* Replace XX with material/code required: ■ PE100 Black = 40 ■ PE100 Blue = 41

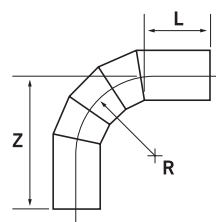

### END CAPS

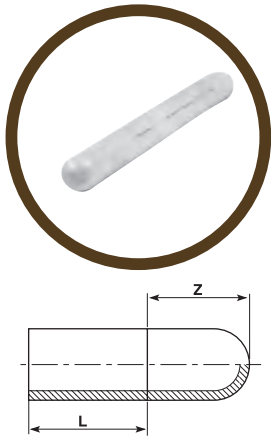

\* Replace XX with material/code required:

- PE100 Black = 40
- PE100 Blue = 41

Size (mm)	SDR 11 Code*	SDR 17 Code*	L (mm)	Z (mm)	SDR 11 Weight (kg)	SDR 17 Weight (kg)
90	XX 332 313	XX 331 313	500	109	1.3	0.9
110	XX 332 314	XX 331 314	500	122	3.6	2.5
125	XX 332 315	XX 331 315	500	128	2.6	1.8
160	XX 332 317	XX 331 317	500	156	7.7	5.3
180	XX 332 318	XX 331 318	500	167	5.7	3.9
200	XX 332 319	XX 331 319	500	163	12.4	8.4
225	XX 332 320	XX 331 320	500	180	15.0	10.7
250	XX 332 321	XX 331 321	500	217	11.8	8.0
280	XX 332 322	XX 331 322	500	239	15.2	10.2
315	XX 332 323	XX 331 323	500	256	19.8	13.4
355	XX 332 324	XX 331 324	500	291	26.2	17.8
400	XX 332 325	XX 331 325	500	316	34.6	23.3
450	XX 332 326	XX 331 326	1000	95	64.7	46.2
500	XX 332 327	XX 331 327	1000	105	81.7	57.9

Maximum continuous operating pressure SDR 11 - 16 bar water (EN 12201-3)  
 Maximum continuous operating pressure SDR 17 - 10 bar water (EN 12201-3)

### 45° MITRED ELBOWS



\* Replace XX with material/code required:

- PE100 Black = 40
- PE100 Blue = 41

Size (mm)	SDR 11 Code*	SDR 17 Code*	SDR 21 Code*	L (mm)	Z (mm)	SDR 11 Weight (kg)	SDR 17 Weight (kg)	SDR 21 Weight (kg)
90	XX 242 313	XX 2XX 313	-	500	538	2.3	1.6	-
110	XX 242 314	XX 2XX 314	-	500	546	3.5	2.4	-
125	XX 242 315	XX 2XX 315	-	500	553	5.0	3.0	-
160	XX 242 317	XX 2XX 317	XX 247 317	500	568	8.0	6.0	5.0
180	XX 242 318	XX 2XX 318	XX 247 318	500	576	10.0	7.0	6.0
200	XX 242 319	XX 2XX 319	XX 247 319	500	584	13.3	9.0	7.4
225	XX 242 320	XX 2XX 320	XX 247 320	500	595	17.0	12.0	9.0
250	XX 242 321	XX 2XX 321	XX 247 321	500	606	20.0	14.0	12.0
280	XX 242 322	XX 2XX 322	XX 247 322	500	618	25.0	17.0	15.0
315	XX 242 323	XX 2XX 323	XX 247 323	500	632	33.0	22.0	19.0
355	XX 242 324	XX 2XX 324	XX 247 324	500	650	42.0	29.0	25.0
400	XX 242 325	XX 2XX 325	XX 247 325	500	669	55.0	37.0	33.0
450	XX 242 326	XX 2XX 326	XX 247 326	1000	1191	124.0	84.0	42.0
500	XX 242 327	XX 2XX 327	XX 247 327	1000	1211	156.0	106.0	89.0
560	XX 242 328	XX 2XX 328	XX 247 328	1000	1237	200.0	131.0	114.0
630	XX 242 329	XX 2XX 329	XX 247 329	1000	1266	260.0	175.0	147.0
710	XX 242 330	XX 2XX 330	XX 247 330	1000	1300	340.0	230.0	191.0
800	-	XX 2XX 332	XX 247 332	1000	1339	-	300.0	249.0
900	-	XX 2XX 333	XX 247 333	1000	1380	-	399.6	325.0
1000	-	XX 2XX 334	XX 247 334	1000	1422	-	505.9	412.0
1200	-	XX 2XX 335	XX 247 335	1000	1507	-	769.2	628.0

Maximum continuous operating pressure SDR 11 - 16 bar water (EN 12201-3)  
 Maximum continuous operating pressure SDR 17 - 10 bar water (EN 12201-3)  
 Maximum continuous operating pressure SDR21 - 8 bar water (EN 12201-3)  
 For water applications, de-rate the pressure rating of 22.5°, 45° and 90° mitred bends to 0.8 x the pipe rating from which it was made.  
 We can supply longer legs for some butt fusion machines or shorter (long spigot) for electrofusion.  
 R = Radius of curvature = approx 1.5 x D (the pipe size)

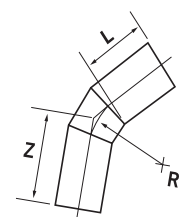

Dimensions of pupped fittings should be used subject to a +/- 5mm tolerance due to the nature of the fabrication process. Standard pup leg lengths: 0.5m in sizes up to 400mm; 1.0m in sizes 450mm to 1200mm. Additional bespoke large diameter fabricated fittings are available to order – please contact our Sales Office for further information.

## 22½° MITRED ELBOWS

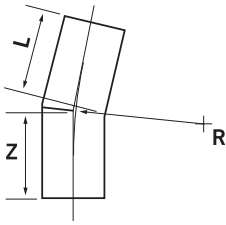
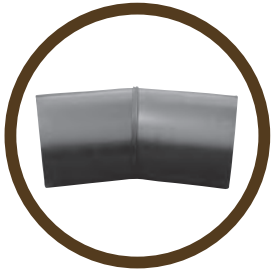

Size (mm)	SDR 11 Code*	SDR 17 Code*	SDR 21 Code*	L (mm)	Z (mm)	SDR 11 Weight (kg)	SDR 17 Weight (kg)	SDR 21 Weight (kg)
90	XX 317 313	XX 316 313	-	500	509	2.2	1.5	-
110	XX 317 314	XX 316 314	-	500	511	3.2	2.2	-
125	XX 317 315	XX 316 315	-	500	514	4.2	2.8	-
160	XX 317 317	XX 316 317	XX 246 317	500	516	7.0	5.0	4.0
180	XX 317 318	XX 316 318	XX 246 318	500	518	9.0	6.0	5.0
200	XX 317 319	XX 316 319	XX 246 319	500	520	11.6	7.8	6.4
225	XX 317 320	XX 316 320	XX 246 320	500	522	15.0	10.0	8.0
250	XX 317 321	XX 316 321	XX 246 321	500	525	18.0	12.0	10.0
280	XX 317 322	XX 316 322	XX 246 322	500	528	28.0	19.0	12.0
315	XX 317 323	XX 316 323	XX 246 323	500	531	29.0	20.0	16.0
355	XX 317 324	XX 316 324	XX 246 324	500	535	35.0	30.0	20.0
400	XX 317 325	XX 316 325	XX 246 325	500	540	45.0	31.0	26.0
450	XX 317 326	XX 316 326	XX 246 326	1000	1045	110.0	75.0	62.0
500	XX 317 327	XX 316 327	XX 246 327	1000	1051	136.0	92.0	77.0
560	XX 317 328	XX 316 328	XX 246 328	1000	1056	172.0	113.0	97.0
630	XX 317 329	XX 316 329	XX 246 329	1000	1063	220.0	150.0	123.0
710	XX 317 330	XX 316 330	XX 246 330	1000	1071	285.0	190.0	157.0
800	-	XX 316 332	XX 246 332	1000	1080	-	245.0	201.0
900	-	XX 316 333	XX 246 333	1000	1090	-	315.5	257.0
1000	-	XX 316 334	XX 246 334	1000	1099	-	393.3	320.0
1200	-	XX 316 335	XX 246 335	1000	1119	-	576.3	470.0

Maximum continuous operating pressure SDR 11 - 16 bar water (EN 12201-3)

Maximum continuous operating pressure SDR 17 - 10 bar water (EN 12201-3)

Maximum continuous operating pressure SDR21 - 8 bar water (EN 12201-3)

For water applications, de-rate the pressure rating of 22.5°, 45° and 90° mitred bends to 0.8 x the pipe rating from which it was made.

We can supply longer legs for some butt fusion machines or shorter (long spigot) for electrofusion.

R = Radius of curvature = approx 1.5 x D (the pipe size)

\* Replace XX with material/code required: ■ PE100 Black = 40 ■ PE100 Blue = 41

**11¼°  
MITRED ELBOWS**

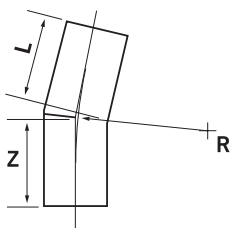
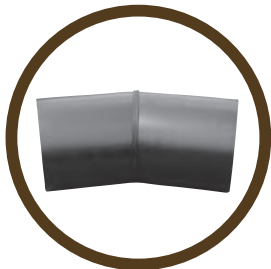

Size (mm)	SDR 11 Code*	SDR 17 Code*	SDR 21 Code*	L (mm)	Z (mm)	SDR 11 Weight (kg)	SDR 17 Weight (kg)	SDR 21 Weight (kg)
90	XX 298 313	XX 297 313	-	500	504	2.1	1.5	-
110	XX 298 314	XX 297 314	-	500	505	3.2	2.2	-
125	XX 298 315	XX 297 315	-	500	506	4.1	2.8	-
160	XX 298 317	XX 297 317	XX 245 317	500	508	7.0	5.0	4.0
180	XX 298 318	XX 297 318	XX 245 318	500	509	9.0	6.0	5.0
200	XX 298 319	XX 297 319	XX 245 319	500	510	11.3	7.7	6.3
225	XX 298 320	XX 297 320	XX 245 320	500	511	14.0	10.0	8.0
250	XX 298 321	XX 297 321	XX 245 321	500	512	17.0	12.0	10.0
280	XX 298 322	XX 297 322	XX 245 322	500	514	21.0	15.0	12.0
315	XX 298 323	XX 297 323	XX 245 323	500	516	21.0	15.0	16.0
355	XX 298 324	XX 297 324	XX 245 324	500	518	34.0	29.0	20.0
400	XX 298 325	XX 297 325	XX 245 325	500	520	44.0	30.0	25.0
450	XX 298 326	XX 297 326	XX 245 326	1000	1022	110.0	75.0	61.0
500	XX 298 327	XX 297 327	XX 245 327	1000	1025	133.0	90.0	75.0
560	XX 298 328	XX 297 328	XX 245 328	1000	1028	168.0	110.0	94.0
630	XX 298 329	XX 297 329	XX 245 329	1000	1031	215.0	145.0	120.0
710	XX 298 330	XX 297 330	XX 245 330	1000	1035	275.0	185.0	152.0
800	-	XX 297 332	XX 245 332	1000	1039	-	235.0	194.0
900	-	XX 297 333	XX 245 333	1000	1044	-	315.5	245.0
1000	-	XX 297 334	XX 245 334	1000	1049	-	393.3	308.0
1200	-	XX 297 335	XX 245 335	1000	1059	-	576.3	445.0

Maximum continuous operating pressure SDR 11 - 16 bar water (EN 12201-3)  
 Maximum continuous operating pressure SDR 17 - 10 bar water (EN 12201-3)  
 Maximum continuous operating pressure SDR21 - 8 bar water (EN 12201-3)  
 We can supply longer legs for some butt fusion machines or shorter (long spigot) for electrofusion.  
 R = Radius of curvature = approx 1.5 x D (the pipe size)  
 \* Replace XX with material/code required: ■ PE100 Black = 40 ■ PE100 Blue = 41

## SERVICE COIL DISPENSER BAGS



Weight (kg)	Product Code
0.5	53 590 100

Suitable for 25mm and 32mm pipe coils.

## ELECTROFUSION WIPES



Item	Product Code
Electrofusion iso-propyl Alcohol Wipes 100% (100 per tub)	53 996 603

## ELECTROFUSION PIN ADAPTORS 4.7 – 4.0MM



Description	Product Code
Reusable (Pair)	53 EWO 002
Economy (Each)	C0 101 102

## FRIALEN® PIPE-MARKER



Item	Product Code
Silver (pack of 10)	FE 613 069



## → Gatehampton Borehole upgrade

Thames Water used Excel pipes as part of Gatehampton Borehole Upgrade, the largest groundwater abstraction project in Europe.

The Gatehampton Borehole Upgrade Project is part of the Thames Water GATOX (Gatehampton to Oxford) scheme, which helped to boost the amount of water available for customers in Swindon and Oxford from 87 to 105 million litres a day (average).

This took effect in June 2009 when a surge vessel has been installed to protect the main to Cleeve.

The largest groundwater abstraction project in Europe, Gatehampton comprises seven boreholes. When linked to form a ring, they provide substantially increased flow management to the Cleeve Water Treatment Works.

The supply of polyethylene pipes to Thames Water's Gatehampton Borehole Upgrade Project has called for a measured approach by GPS PE Pipe Systems. Pipework operating pressures and local access restrictions were studied in depth by the manufacturer, before delivering the best-value/cost solution.



One of the difficulties faced by the contractor, Black and Veatch was that new pipes had to be installed within a small village, Goring-on-Thames. GPS investigated

the delivery route to assess the problems of transporting pipe lengths around narrow access roads and tight bends.

As a result GPS produced and delivered the pipe in 12m lengths, rather than the 18m option, more typical of large installations. The company's diligent groundwork was recognised and GPS was awarded the order for the full scope of sizes on the project, from 355mm up to 800mm.

Analysis of the new pipework scheme by GPS design engineers, working with the project team, led to the specification of Excel (PE100) pipe in SDR17, which denotes the relative wall thickness of the pipe and strongly influences its pressure rating. Installed by open-cut, the PE pipes simplified the installation procedure through their ability to be 'snaked' into the trenches, as flexible pipe strings with very few mitred joints.

In total some 1600m of butt-fusion jointed PE pipe were required to complete the work. Although the new pipe was not originally included in the project, delamination and bursts in the locality's existing GRP pipes created the need for a system replacement. Thames Water favoured polyethylene as the most suitable material to handle pressure surges from the boreholes.



St. Peter's Road  
Huntingdon  
PE29 7DA  
United Kingdom  
T: +44 (0)1480 442600  
customerservice@alixaxis.com

